



PRODUCT CATALOG

CAST IRON SOIL PIPE & FITTINGS



NO-HUB PIPE & FITTINGS

HUB & SPIGOT (SV) PIPE & FITTINGS

ACCESSORIES



TABLE OF CONTENTS

NO-HUB FITTINGS

ADAPTERS

Hub Adapter	15
Tapped Adapter	17
Extended Tapped Adapter	17

BENDS

¼ Bend	5
¼ Bend w/low heel inlet	5
¼ Bend Tapped	6
¼ Bend Extended	6
¼ Bend w/extended low heel inlet	6
Double ¼ Bend	7
¼ Bend Short Sweep	7
Extended Short Sweep	7
¼ Bend Long Sweep	8
½ Bend	8
⅙ Bend	8
⅛ Bend	9
⅛ Bend Extended	9
⅙ Bend	9

CLEANOUTS

IBCO or Ferrule	27
Iron Body Tapped Cleanout	27
Two-Way Cleanout (Kelly)	28
Twin Cleanout (E. Bay Code)	28
Texas Twin Cleanout	28

CLOSET BENDS

Closet Bends	41
Closet Bends Reducing	41

CLOSET FITTINGS

Vented Closet Tee	31
Vented Closet Cross	31

CLOSET FLANGES

2-252 Closet Flange	43
---------------------	----

CLOSET RINGS

No-Hub Closet Rings	42
Best Set™ Closet Rings	42

CROSSES

Sanitary Cross	12-14
Sanitary Tap Cross	14

FIGURE FITTINGS

Figure 1	29
Figure 5	29
Figure 6	29

FIGURE FITTINGS CONT.

Figure 6 Double	29
Figure 8	30
Figure 8 Double	30
Figure 8 Double Extended	30

FITTINGS

Blind Plug Cleanout Fitting	21
Prison Fitting	23

INCREASERS/REDUCERS

Increases-Reducers	17
Reducer (Short)	16

PIPE

Silverspun™ No-Hub Pipe	4
-------------------------	---

SPECIAL FITTINGS

Rufwall	33-34
---------	-------

STARTER FITTINGS

Trim Packages	38-40
---------------	-------

TEES

Sanitary Tee	10-11
Sanitary Tap Tee	12
Test Tee	15
Double Verticle Tapped Tee	32
Horizontal Twin San Tapped Tee	32

TRAPS

"P" Traps	24-26
Side Inlet "P" Trap	25
Running Trap w/single vent	25
"P" Trap w/ double vent	25
Deep Seal "P" Trap	24
"P" Trap Reducing	26

VENT BYPASS

2" Bypass Vent Fitting	23
------------------------	----

WYE

Wye	18
Comb Wye & ⅙ Bend	20
Dbl Comb Wye & ⅙ Bend	21
Double Wye	19
Upright Wye	19
Vented Tub Wye NH	22
Tapped Wye	32

TABLE OF CONTENTS

SV HUB & SPIGOT FITTINGS

ADAPTERS

Double Hub Fitting 67

BENDS

¼ Bend 47

¼ Bend w/ low heel inlet 48

¼ Bend Reducing 49

Double ¼ Bend 49

⅙ Bend 51

⅛ Bend 52

⅙ Bend 53

Long ¼ Bend 47

Long ⅛ Bend 52

Long Sweep ¼ Bend 50

Single Hub Return Bend 53

Short Sweep ¼ Bend 50

CLEANOUTS

Twin Cleanout (Memphis) 64

Two-Way Double Cleanout 64

CLOSET BENDS

Closest Bends 73

Closest Bends Reducing 73

Closest Bends Regular Hub 74

Closest Bend Tapped 74

CLOSET FLANGES

2-252 Closet Flange 75

CLOSET FITTINGS

Vented Closet Tee 80

Vented Closet Cross 80

CROSSES

Sanitary Cross 57

Tapped Sanitary Cross 58

Straight Tapped Cross 58

FERRULES

2-11 Standard Ferrule 72

GASKETS

EZ-TITE SV 89

Lubri/Fast® Lubricant 90

TY-SEAL 89

TY-SEAL Lubricant 90

TY-Tools 90

INCREASERS/REDUCERS

Reducer 65

Increaser 66

Long Plain Increaser 66

Long Tapped Increaser 66

PIPE

Hub & Spigot Pipe 44-46

PLUGS

Pipe Plug 67

SISSION INSERTABLE JOINT 76

STARTER FITTINGS 81-85

Trim Packages 86-88

TAPPED SPIGOT 76

TEES

Sanitary Tee 54, 56, 77

Tapped Sanitary Tee 55

Straight Tapped Tee 55

2-70 Test Tee

(Type "A" less plug) 71

2-70 Test Tee

(Type "A" with plug) 71

Long San Tapped Tee 77

Tapped Long Sweep Tee 77

TRAPS

"P" Trap 68, 79

Running Trap 70

Running Trap

w/ Single Vent 69

Running Trap

w/ 2 Hub Vents 70

"P" Trap

w/ ½" Heel Tap 68

Deep Seal "P" Trap 69

VENT BYPASS 79

VENT CAP WITH SCREW 76

WYE

Wye 59

Combination & ⅛ Bend 62-63

Double Comb & ⅛ Bend Wye 64

Double Wye 60

Wye with Side Inlet 61

Tapped Wye 78

Tapped Double Wye 78

Tapped Bath Vent Wye 78

WARRANTY INFORMATION 91



QUALITY SILVERSPUN™ NO-HUB PIPE



SILVERSPUN™ 10' NO-HUB PIPE The Finest No-Hub Pipe Available!

Part No	Size	Unit Wt.	Pcs/Pkg	Total Ft.	Pkg. Wt.
00156	1½" x 10'	30	54	540	1620
00158	2 x 10'	36	64	640	2304
00160	3 x 10'	54	48	480	2592
00162	4 x 10'	74	30	300	2220
00164	5 x 10'	90	24	240	2160
00168	6 x 10'	115	21	210	2415
00170	8 x 10'	165	15	150	2475
00172	10 x 10'	265	8	80	2120
00182	12 x 10'	325	6	60	1950
00185	15 x 10'	435	3	30	1305

DIMENSIONS AND TOLERANCES NO-HUB PIPE BARRELS

Size	B Inside Diameter	J Outside Diameter	-T Thickness-	
			Norm.	Min.
1½"	1.50±.09	1.90±.06	.16	.13
2"	1.96±.09	2.35±.09	.16	.13
3"	2.96±.09	3.35±.09	.16	.13
4"	3.94±.09	4.38±.09-.05	.19	.15
5"	4.94±.09	5.30±.09-.05	.19	.15
6"	5.94±.09	6.30±.09-.05	.19	.15
8"	7.94±.13	8.38±.13-.09	.23	.17
10"	10.00 ±.13	10.56 ±.09	.28	.22
12"	11.94±.13	12.50±.13	.28	.22
15"	15.11±.13	15.83±.13	.36	.30

NO-HUB FITTINGS

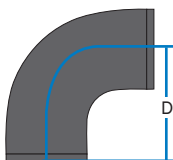

1/4 BEND

Part No.	Size	D	Wt.
00188	1½"	4¼	2
00190	2"	4½	3
00192	3"	5	4
00194	4"	5½	7
00196	5"	6½	9
00198	6"	7	14
00200	8"	8½	34
00218	4 x 3"	5½	6

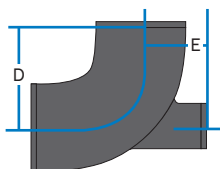

1/4 BEND WITH LOW HEEL INLET

Part No.	Size	D	E	Wt.
00280	3 x 2"	5	2⅞	5
00282	4 x 2"	5½	3¼	9

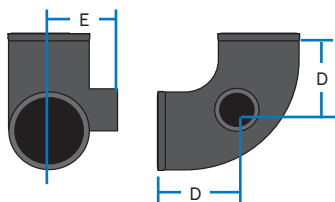

1/4 BEND WITH 2" SIDE OPENING

Part No.	Size	D	E	Wt.
06923	3 x 2"	4	3¼	4
06930	4 x 2"	4⅝	3¾	8

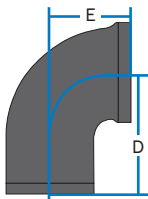

1/4 BEND TAPPED

Part No.	Size	D	E	Wt.
00326	1½ x 1½"	3	2	2
00335	2 x 1¼"	3¼	2¼	2
00330	2 x 1½"	3¼	2¼	2
00332	2 x 2"	3¼	2¼	2

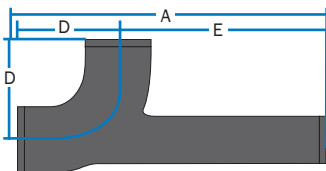

1/4 BEND EXTENDED LOW HEEL INLET

Part No.	Size	A	D	E	Wt.
08172	3 x 2"	15½	5	10½	8

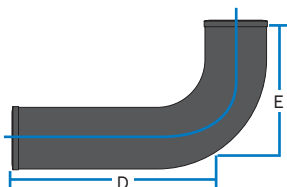

1/4 BEND EXTENDED

Part No.	Size	D	E	Wt.
07067	2 x 12"	12	4½	5
00425	2 x 18"	18	4½	7
62875	2 x 24"	24	4½	11
07081	3 x 12"	12	5	7
07098	3 x 18"	12	5	7
07104	4 x 12"	12	5½	10

NO-HUB FITTINGS

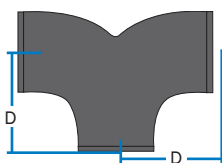

DOUBLE 1/4 BEND

Part No.	Size	D	Wt.
00402	2"	4½	4
00404	3"	5	6
00406	4"	5½	12

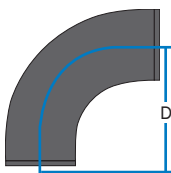

1/4 BEND SHORT SWEEP

Part No.	Size	D	Wt.
00462	2"	6½	4
00464	3"	7	6
00468	4"	7½	10
00470	5"	8½	12
00472	6"	9	19
00474	8"	10½	28
00476	10"	12	68
00482	12"	13¼	77
00485	15"	14¾	122

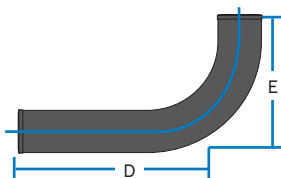

EXTENDED SHORT SWEEP

Part No.	Size	D	E	Wt.
19077	2 x 12"	12	6½	7
19091	2 x 16"	16	6½	11
19107	2 x 18"	18	6½	7
19060	2 x 24"	24	6½	11
20431	2 x 34"	34	6½	17

AB&I Foundry
800/GOT-IRON • ABIFoundry.com

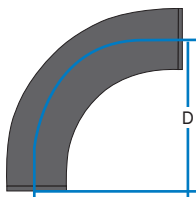

1/4 BEND LONG SWEEP

Part No.	Size	D	Wt.
00492	1½"	9¼	4
00494	2"	9½	5
00496	3"	10	8
00498	4"	10½	13
07258	4 x 3"	10½	12
00500	5"	11½	15
00502	6"	12	19

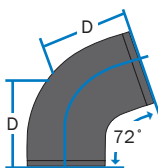

1/5 BEND

Part No.	Size	D	Wt.
00536	2"	3 ¹ / ₁₆	2
00538	3"	4 ¹ / ₁₆	4
00540	4"	4 ⁷ / ₁₆	7

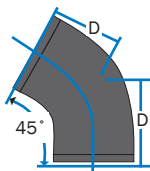

1/6 BEND

Part No.	Size	D	Wt.
00570	2"	3¼	2
00572	3"	3½	4
00574	4"	3 ¹³ / ₁₆	6

NO-HUB FITTINGS

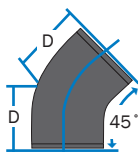

1/8 BEND

Part No.	Size	D	Wt.
00604	1½"	2 ⁵ / ₈	1
00606	2"	2 ³ / ₄	2
00608	3"	3	3
00610	4"	3 ¹ / ₈	5
00612	5"	3 ⁷ / ₈	7
00614	6"	4 ¹ / ₁₆	9
00616	8"	5	20
00617	10"	5 ¹⁵ / ₁₆	28
00622	12"	6 ⁹ / ₁₆	39
00625	15"	7 ³ / ₁₆	62

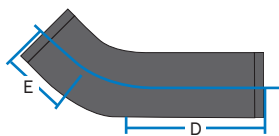

1/8 BEND EXTENDED

Part No.	Size	D	E	Wt.
00636	2 x 6"	6	3	3
00638	2 x 12"	12	2 ³ / ₄	6
00643	2 x 18"	18	2 ³ / ₄	7
07425	3 x 12"	12	3	8
07463	3 x 18"	18	3	10
07449	4 x 12"	12	3 ¹ / ₈	11

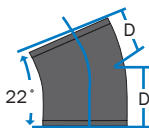

1/16 BEND

Part No.	Size	D	Wt.
00676	1½"	2 ¹ / ₈	1
00678	2"	2 ¹ / ₈	2
00680	3"	2 ¹ / ₄	2
00682	4"	2 ⁵ / ₁₆	4
00684	5"	2 ⁷ / ₈	6
00686	6"	3	6
00688	8"	3 ³ / ₄	14

AB&I Foundry
800/GOT-IRON • ABIFoundry.com

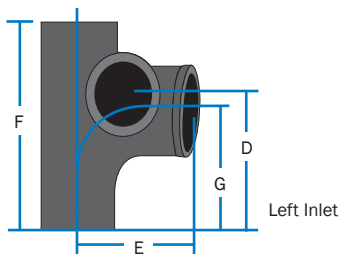

SANITARY TEE

(with 2" 45° side opening above center)

(New Orleans code)

Part No.	Size	D	E	F	G	Wt.
00975	3"LH	6	5	8½	5	6
00985	3"RH	6	5	8½	5	6
87831	3"RH&LH	6	5	8½	5	8
07920	4"LH	6½	5½	9⅛	5½	9
07944	4"RH	6½	5½	9⅛	5½	9

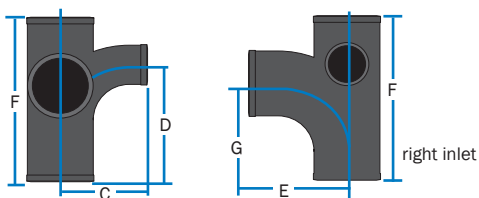

SANITARY TEE

(with 2" 90° side openings above center)

(New Orleans code)

Part No.	Size	C	D	E	F	G	Wt.
07838	3"LH	4½	6	5	8½	5	6
07852	3"RH	4½	6	5	8½	5	6
07876	3"R&L	4½	6	5	8½	5	7
07845	4"LH	5	6½	5½	9⅛	5½	10
07869	4"RH	5	6½	5½	9⅛	5½	10
07883	4"R&L	5	6½	5½	9⅛	5½	10

NO-HUB FITTINGS

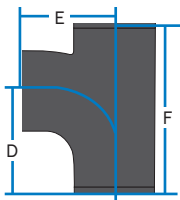

SANITARY TEE

Part No.	Size	D	E	F	Wt.
00806	1½"	4¼	4¼	6½	3
00808	2 x 1½"	4¼	4½	6 ⁵ / ₈	4
00810	2"	4½	4½	6 ⁷ / ₈	4
00812	3 x 1½"	4¼	5	6½	5
00814	3 x 2"	4½	5	6 ⁷ / ₈	4
00816	3"	5	5	8	5
00818	4 x 2"	4½	5½	6 ⁷ / ₈	7
00820	4 x 3"	5	5½	8	7
00822	4"	5½	5½	9 ¹ / ₈	11
00824	5 x 2"	5	6	8½	9
00826	5 x 3"	5½	6	9 ⁵ / ₁₆	10
00828	5 x 4"	6	6	10 ¹³ / ₃₂	12
00830	5"	6½	6½	11 ⁷ / ₁₆	13
00832	6 x 2"	5	6½	8 ³ / ₁₆	10
00838	6 x 3"	5½	6½	9 ³ / ₁₆	11
00834	6 x 4"	6	6½	10 ¹ / ₁₆	12
00840	6 x 5"	6½	7	11½	17
00836	6"	7	7	12½	19
00844	8 x 3"	6	7½	10 ³ / ₈	20
00843	8 x 4"	6½	7½	11½	21
00848	8 x 5"	7	8	12½	23
00842	8 x 6"	7½	8	13½	25
00850	8"	8½	8½	15½	32

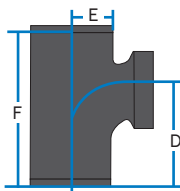

SANITARY TAP TEE

Part No.	Size	D	E	F	Wt.
01210	1½ x 1½"	3¼	2 ⁹ / ₁₆	5 ¹¹ / ₁₆	2
01212	2 x 1¼"	3¼	2 ¹³ / ₁₆	5 ¹¹ / ₁₆	3
01214	2 x 1½"	3¼	2 ¹³ / ₁₆	5 ¹¹ / ₁₆	3
01216	2 x 2"	3¾	3 ¹ / ₁₆	6 ³ / ₈	3
01220	3 x 1½"	3¼	3 ⁵ / ₁₆	5 ¹¹ / ₁₆	4
01222	3 x 2"	3¾	3 ⁹ / ₁₆	6 ³ / ₈	4
01223	3 x 3"	4 ⁷ / ₈	4 ³ / ₁₆	8	7
01226	4 x 1½"	3¼	3 ¹³ / ₁₆	5 ¹¹ / ₁₆	5
01228	4 x 2"	3¾	4 ¹ / ₁₆	6 ³ / ₈	5
83277	4 x 3"	4½	4 ³ / ₈	8	7
01232	5 x 1½"	3¾	4 ⁵ / ₁₆	6 ¹¹ / ₁₆	6
01234	5 x 2"	4¼	4 ⁹ / ₁₆	7 ¹⁵ / ₁₆	7
01238	6 x 1½"	3¾	4 ¹³ / ₁₆	6¾	9
01240	6 x 2"	4¼	5 ¹ / ₁₆	7 ⁷ / ₁₆	8

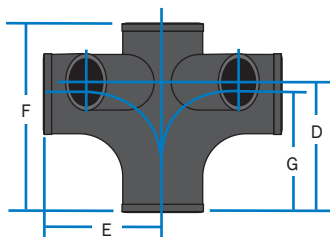

SANITARY CROSS

(with 2" 45° sanitary opening same side)

(New Orleans code)

Part No.	Size	D	E	F	G	Wt.
09252	3"	6	5	8½	5	8
09269	4"	6	5½	9 ¹ / ₈	5½	11

NO-HUB FITTINGS

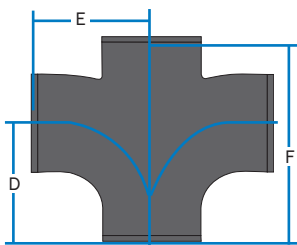

SANITARY CROSS

Part No.	Size	D	E	F	Wt.
01850	1½"	4¼	4¼	6½	3
01852	2"	4½	4½	6⅞	4
01854	3 x 2"	4½	5	6⅞	6
01856	3"	5	5	8	7
01858	4 x 2"	4½	5½	6⅞	7
01860	4 x 3"	5	5½	8	8
01862	4"	5½	5½	9⅙	10
01864	6 x 4"	6	6½	10⅙	14
01866	6"	7	12½	7	21
09160	8 x 4"	6½	7½	11½	26
89866	8"	8½	8½	15½	29

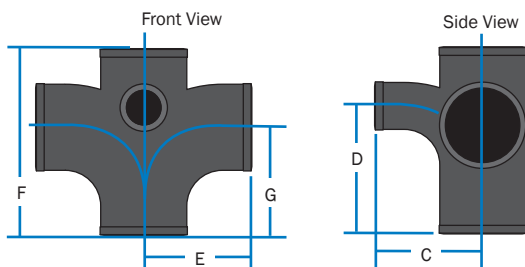

SANITARY CROSS

(with one 2" 90° sanitary openings above center)

(New Orleans code)

Part No.	Size	C	D	E	F	G	Wt.
09238	4"	5	6½	5½	9⅞	5½	11

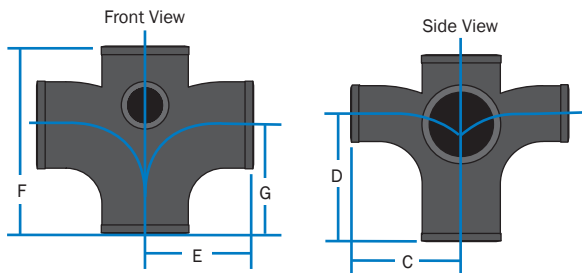

SANITARY CROSS

(with two 2" 90° sanitary opening above center)
(New Orleans code)

Part No.	Size	C	D	E	F	G	Wt.
09221	3"	4½	6	5	8½	5	9
09245	4"	5	6½	5½	9⅞	5½	12

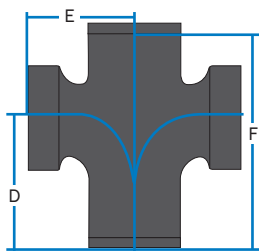

SANITARY TAP CROSS

Part No.	Size	D	E	F	Wt.
09283	1½ x 1½"	3¼	2⅞	5⅞	3
02014	2 x 1¼"	3¼	2⅜	5⅞	3
02016	2 x 1½"	3¼	2⅜	5⅞	4
02018	2 x 2"	3¾	3⅞	6⅜	4
09337	3 x 1½"	3¼	3⅞	5⅞	5
02024	3 x 2"	3¾	3⅞	6⅜	5
02028	4 x 1½"	3¼	3⅜	5⅞	6
02030	4 x 2"	3¾	4⅞	6⅜	8

NO-HUB FITTINGS

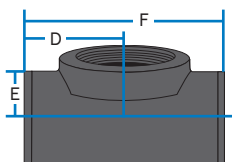

TEST TEE (less brass plug)

Part No.	Size	E	F	D	IPS Tap	Wt .
02046	2"	2	6 ³ / ₈	3 ³ / ₁₆	2"	3
02048	3"	2 ¹ / ₁₆	7 ³ / ₄	3 ⁷ / ₈	3"	6
02050	4"	3	8 ⁷ / ₈	4 ⁷ / ₁₆	4"	11
02052	5"	4 ¹ / ₂	11 ¹ / ₂	5 ³ / ₄	5"	16
02054	6"	5	12 ¹ / ₂	6 ¹ / ₄	6"	23
02056	8"	6	15 ¹ / ₄	7 ⁵ / ₈	8"	38
02058	10"	6 ¹ / ₂	20	10	10"	57

TEST TEE WITH TYPE A BRASS PLUG INSTALLED

Part No.	Size	E	F	D	IPS Tap	Wt .
11736	2"	2	6 ³ / ₈	3 ³ / ₁₆	2"	3
11743	3"	2 ¹ / ₁₆	7 ³ / ₄	3 ⁷ / ₈	3"	6
11750	4"	3	8 ⁷ / ₈	4 ⁷ / ₁₆	4"	10
11767	5"	4 ¹ / ₂	11 ¹ / ₂	5 ³ / ₄	5"	16
11774	6"	5	12 ¹ / ₂	6 ¹ / ₄	6"	21
11781	8"	6	15 ¹ / ₄	7 ⁵ / ₈	8"	34

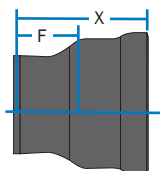

HUB ADAPTER

Part No.	Size	X	F	Wt.
02222	2"	4 ¹ / ₂	2	3
02224	3"	4 ³ / ₄	2	3
02226	4"	5 ¹ / ₄	2 ¹ / ₄	5

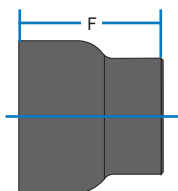

REDUCER
(short)

Part No.	Size	F	Wt.
02138	2 x 1½"	3 ⁵ / ₈	1
02140	3 x 2"	3 ⁵ / ₈	1.7
02142	4 x 2"	3 ⁵ / ₈	2
02144	4 x 3"	3 ⁵ / ₈	2
83314	5 x 2"	4	3
02148	5 x 3"	4	4
02150	5 x 4"	4	4
02152	6 x 2"	4	4
02154	6 x 3"	4	5
02156	6 x 4"	4	4
02158	6 x 5"	4½	5
02160	8 x 2"	4½	8
02162	8 x 3"	4½	8
02164	8 x 4"	4½	7
02166	8 x 5"	5	9
02168	8 x 6"	5	8
02172	10 x 4"	5½	16
02174	10 x 6"	6	15
02175	10 x 8"	6	15
02184	12 x 4"	6½	20
02186	12 x 6"	6½	20
02188	12 x 8"	7	21
02190	12 x 10"	7½	25
02204	15 x 4"	7	32
02206	15 x 6"	7	35
02208	15 x 8"	7	34
02210	15 x 10"	7½	38
02212	15 x 12"	7¾	36

NO-HUB FITTINGS

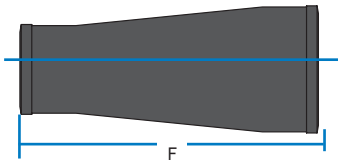

INCREASER - REDUCER

Part No.	Size	F	Wt.
09658	3 x 4"	8	5

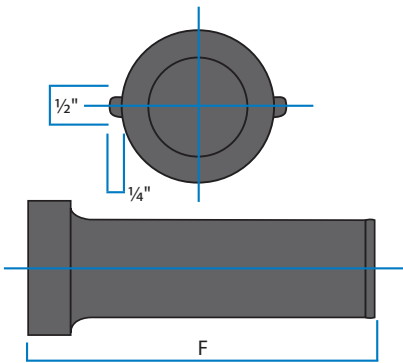

EXTENDED TAPPED ADAPTER

Part No.	Size	F	Wt.
02280	2 x 1½ x 18"	18	6
02282	2 x 2 x 18"	18	6

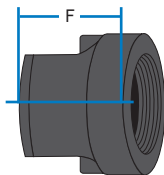

TAPPED ADAPTER

Part No.	Size	F	IPS	Wt.
02238	1½ x 1½"	2 ⁵ / ₈	1½"	1
02242	2 x 1½"	2 ³ / ₁₆	1½"	1
02244	2 x 2"	2 ⁵ / ₈	2"	2
09948	3 x 2"	2 ³ / ₁₆	2"	1

AB&I Foundry
800/GOT-IRON • ABIFoundry.com



NO-HUB FITTINGS

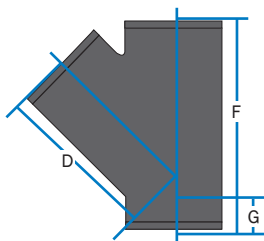

WYE

Part No.	Size	D	F	G	Wt.
01312	1½"	4	6	2	2
01314	2"	4 ⁵ / ₈	6 ⁵ / ₈	2	3
01316	3 x 2"	5 ⁵ / ₁₆	6 ⁵ / ₈	1½	4
01318	3"	5¾	8	2¼	6
01320	4 x 2"	6	6 ⁵ / ₈	1	6
01322	4 x 3"	6½	8	1 ¹ / ₁₆	7
01324	4"	7 ¹ / ₁₆	9½	2 ⁷ / ₁₆	8
01326	5 x 2"	7½	8 ⁷ / ₁₆	1 ⁵ / ₁₆	7
01328	5 x 3"	8	9 ¹ / ₁₆	1 ¹ / ₁₆	9
01330	5 x 4"	8½	11 ³ / ₁₆	2 ⁷ / ₁₆	12
01332	5"	9½	12 ⁵ / ₈	3 ¹ / ₈	15
01334	6 x 2"	8¼	8 ⁵ / ₁₆	½	10
01336	6 x 3"	8¾	9¾	1¼	13
01338	6 x 4"	9¼	11 ³ / ₁₆	1 ¹⁵ / ₁₆	16
01340	6 x 5"	10¼	12½	2 ⁹ / ₁₆	17
01342	6"	10¾	14 ¹ / ₁₆	3 ⁵ / ₁₆	21
01344	8 x 2"	9 ³ / ₈	8½	9 ¹ / ₁₆	16
01346	8 x 3"	9 ¹³ / ₁₆	9 ⁵ / ₁₆	1 ¹ / ₈	18
01348	8 x 4"	10 ³ / ₈	11 ⁷ / ₁₆	1 ⁵ / ₁₆	23
01350	8 x 5"	11 ³ / ₈	12 ¹³ / ₁₆	1 ⁵ / ₈	23
01352	8 x 6"	11 ¹³ / ₁₆	14 ³ / ₁₆	2 ¹⁵ / ₁₆	27
01354	8"	13 ³ / ₈	17 ¹ / ₈	3¾	40
01362	10 x 4"	11 ¹¹ / ₁₆	12 ⁵ / ₈	¾	37
01364	10 x 6"	13 ¹ / ₈	15 ⁷ / ₁₆	2 ³ / ₁₆	48
01365	10 x 8"	14 ¹¹ / ₁₆	18 ³ / ₈	3 ⁵ / ₈	50
01366	10"	16½	21½	5 ¹ / ₁₆	76
01372	12"	19¾	25½	5¾	107
01375	15"	23¼	30	6¾	204

NO-HUB FITTINGS

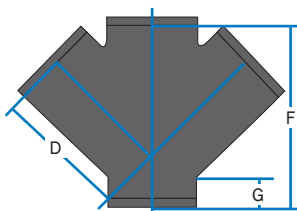

DOUBLE WYE

Part No.	Size	D	F	G	Wt.
01538	2"	4 ⁵ / ₈	6 ⁵ / ₈	2	4
01540	3 x 2"	5 ¹ / ₁₆	6 ⁵ / ₈	1 ¹ / ₂	4
01542	3"	5 ³ / ₄	8	2 ¹ / ₄	6
01544	4 x 2"	6	6 ⁵ / ₈	1	7
01546	4 x 3"	6 ¹ / ₂	8	1 ¹ / ₁₆	7
01548	4"	7 ¹ / ₁₆	9 ¹ / ₂	2 ⁷ / ₁₆	12
01550	5 x 4"	8 ¹ / ₂	11 ³ / ₁₆	2 ⁷ / ₁₆	15
01552	6 x 4"	9 ¹ / ₄	11 ³ / ₁₆	1 ⁵ / ₁₆	18
01554	6"	10 ³ / ₄	14 ¹ / ₁₆	3 ⁵ / ₁₆	23
74445	8 x 4"	10 ³ / ₈	11 ⁷ / ₈	2 ⁵ / ₁₆	23
01557	8 x 6"	11 ¹³ / ₁₆	14 ³ / ₁₆	2 ⁵ / ₁₆	32
01556	8"	13 ³ / ₈	17 ¹ / ₈	3 ³ / ₄	50

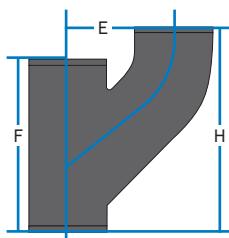

UPRIGHT WYE

Part No.	Size	E	H	F	Wt.
01646	2"	5 ¹ / ₂	10 ¹ / ₄	7	5
01648	3 x 2"	5 ¹ / ₂	9 ¹¹ / ₁₆	7	6
01650	3"	5 ¹ / ₂	10 ⁵ / ₈	8 ³ / ₈	7
01652	4 x 2"	5 ¹ / ₂	9 ¹ / ₄	7	7
01654	4 x 3"	5 ¹ / ₂	10 ¹ / ₈	8 ³ / ₈	10
01656	4"	6	11 ⁹ / ₁₆	9 ³ / ₄	14
08729	5 x 2"	6 ³ / ₄	10	8	8
08750	5"	7 ¹ / ₈	14 ³ / ₁₆	12 ¹¹ / ₁₆	21

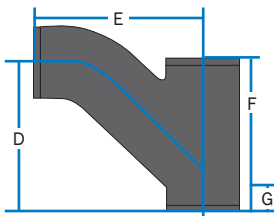
COMBINATION WYE AND 1/8 BEND

Part No.	Size	D	E	F	G	Wt.
01694	1½"	4¾	5¾	6	2	3
01696	2 x 1½"	5	5¾	6	2	3
01698	2"	5¾	6¼	6⅝	2	4
83062	3 x 1½"	5½	6¾	6⅝	1½	4
01700	3 x 2"	5½	6¾	6⅝	1½	6
01702	3"	7⅝	8	8	2¼	7
01704	4 x 2"	5½	7¼	6⅝	1	7
01706	4 x 3"	7¼	8½	8	1⅞	10
01708	4"	9¼	10	9½	2⅞	14
01710	5 x 2"	5⅝	7¾	8⅞	⅝	9
01712	5 x 3"	7¾	9	9⅞	1⅞	12
01714	5 x 4"	9¾	10½	11¾	2⅞	17
01716	5"	11¾	12½	12⅝	3⅞	23
01718	6 x 2"	6	8¼	8⅝	½	11
01720	6 x 3"	7⅞	9½	9¾	1¼	14
01722	6 x 4"	9¾	11	11¾	1⅝	17
01724	6 x 5"	11⅞	13	12½	2⅞	21
01726	6"	13⅝	14⅞	14⅞	3⅝	28
01728	8 x 4"	9⅞	11⅞	11¾	⅞	26
01732	8 x 6"	12	13⅞	13⅝	2¼	31
01734	8"	14¾	15⅞	16⅝	3¾	46.5

NO-HUB FITTINGS

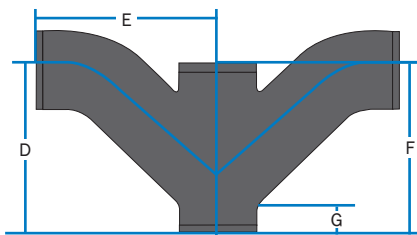

DOUBLE COMBINATION WYE AND $\frac{1}{8}$ BEND

Part No.	Size	D	E	F	G	Wt.
01802	2"	$5\frac{3}{8}$	$6\frac{1}{8}$	$6\frac{5}{8}$	2	6
01804	3 x 2"	$5\frac{1}{2}$	$6\frac{3}{4}$	$6\frac{5}{8}$	$1\frac{1}{2}$	6
01806	3"	$7\frac{5}{16}$	8	8	$2\frac{1}{4}$	12
01808	4 x 2"	$5\frac{1}{2}$	$7\frac{1}{4}$	$6\frac{5}{8}$	1	9
01810	4 x 3"	$7\frac{1}{4}$	$8\frac{1}{2}$	8	$1\frac{11}{16}$	12
01812	4"	$9\frac{1}{4}$	10	$9\frac{1}{2}$	$2\frac{7}{16}$	20



BLIND PLUG

Part No.	Size	F	Wt.
02480	$1\frac{1}{2}$ "	$1\frac{3}{4}$	1
02482	2"	$1\frac{3}{4}$	1
02484	3"	$1\frac{3}{4}$	1
02486	4"	$1\frac{3}{4}$	2
02488	5"	$1\frac{3}{4}$	2
02490	6"	$1\frac{3}{4}$	3
02492	8"	$2\frac{1}{4}$	6
02494	10"	3	13
02496	12"	$3\frac{1}{2}$	18
02498	15"	$3\frac{1}{2}$	33

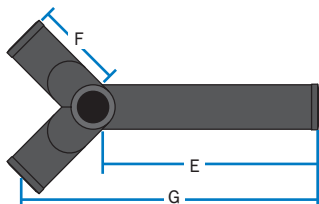

VENTED TUB WYE 9-484 RH

Part No.	Size	E	F	G	Wt.
01414	2"	12	5¼	15¾	8

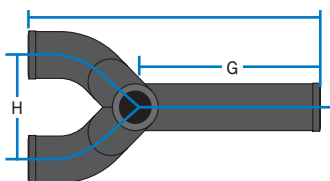

VENTED TUB WYE 9-474

Part No.	Size	G	H	F	Wt.
01412	2 x 15"	9½	5¼	15	9

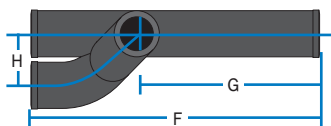

VENTED TUB WYE 9-494 LH

Part No.	Size	G	H	F	Wt.
18131	2"	9½	3¾	16	8

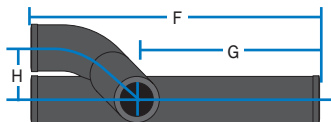

VENTED TUB WYE 9-494 RH

Part No.	Size	G	H	F	Wt.
18148	2"	9½	3¾	16	8

NO-HUB FITTINGS

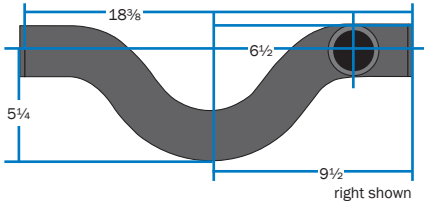

2" VENT BYPASS (right or left hand inlet)

Part No.	Descript.	A	Wt.
09500	9-473 - PLAIN	-	10
09502	9-473-B - RH	-	11
09522	9-473-A - LH	-	11
09524	9-473-A/B - DBL	-	11

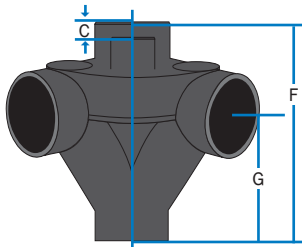

PRISON FITTING (with top vent and 2" opt. tap "A")

Part No.	Size	Description
09112	4"	Standard starter for prisons and correctional construction. Double 90° with single 2" top vent (9-502-A). Fully baffled with tap.
09114	4"	Standard starter for prisons and correctional construction. Double 90° with single 2" top vent (9-502). Fully baffled. No Tap.
09116	4"	Standard starter for prisons and correctional construction. Double 90° with three 2" top vent (9-505). Fully baffled. No Tap.

Part No.	C	G	F	Wt.
09112 With Tap	5 1/4	7 3/4	11 3/4	22
09114 No Tap	5 1/4	7 3/4	11 3/4	22
09116 Plain	5 1/4	7 3/4	11 3/4	22

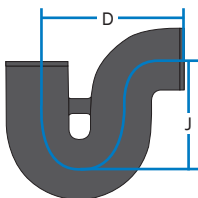

"P" TRAP

Part No.	Size	D	J	Wt.
02506	1½"	6¾	3½	3
02508	2"	7½	4	4
02510	3"	9	5½	9
02512	4"	10½	6½	17
02514	6"	14	7½	30

LONG "P" TRAP

Part No.	Size	D	J	Wt.
02527	2 x 12"	12	4	8
02530	2 x 18"	18	4	9

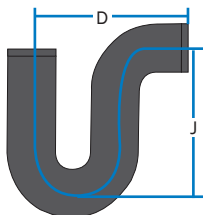

DEEP SEAL "P" TRAP

Part No.	Size	D	J	Wt.
02600	2"	7½	7	6
02610	3"	9	7	13
02567	4"	10½	8	17

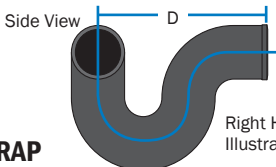
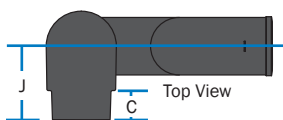

"P" TRAP

(with 2" no-hub side inlet)

Part No.	Size	C	D	J	Wt.
19268	2" LH	1¾	7½	3¼	5
19275	2" RH	1¾	7½	3¼	5

NO-HUB FITTINGS

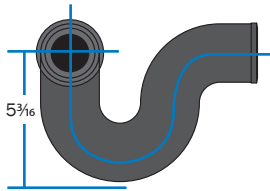

“P” TRAP WITH 1½” TAPPED SIDE INLET

Part No.	Size	Wt.
02602	2 x 1½” LH	6
02604	2 x 1½” RH	6

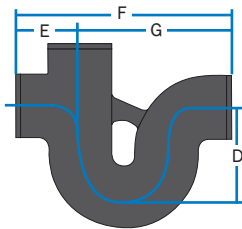

**RUNNING TRAP
(with 4” single vent)**

Part No.	Size	D	E	F	G	Wt.
02570	4 x 4”	6½	4½	15	10½	23.2

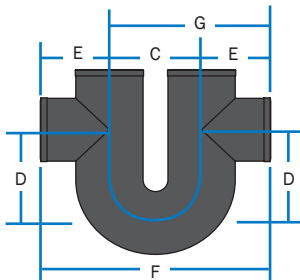

RUNNING TRAP WITH DOUBLE VENT

Part No.	Size	C	D	E	F	G	Wt.
02576	4”	6	6½	4½	15	10½	21

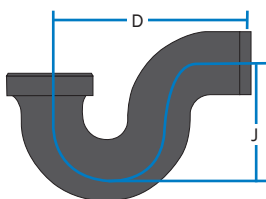

“P” TRAP
(with tapped inlet)

Part No.	Size	D	J	Wt.
02586	2 x 1½"	7½	4	4
02588	2"	7½	4	5

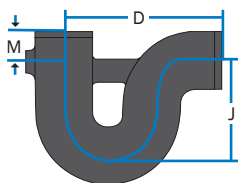

“P” TRAP
(with ½" tap primer)

Part No.	Size	D	J	M	Tap	Wt.
08530	2"	7½	4	2	½	5
08532	3"	9	5½	2	½	10
08534	4"	10½	6½	2	½	18

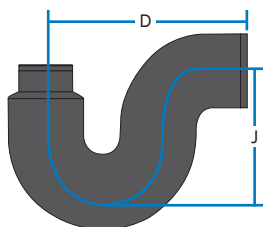

“P” TRAP
(reducing)

Part No.	Size	D	J	Wt.
08548	3 x 2"	9	5½	10

NO-HUB FITTINGS

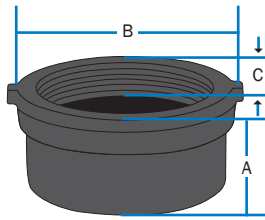

IRONBODY CLEANOUT (Ferrule) (Tapped)

Part No.	Size	Tap	A	B	C	Wt.
08562	2"	1½"	2 ³ / ₁₆	2 ³ / ₈	¾	1
08564	3"	2½"	2 ³ / ₁₆	3 ³ / ₈	¾	2
08566	4"	3½"	2 ³ / ₁₆	4 ⁷ / ₁₆	¾	2
08568	5"	4"	4½	5 ⁵ / ₁₆	1	7
08570	6"	5"	4½	6 ⁵ / ₁₆	1	8
08572	8"	6"	4 ⁵ / ₈	8 ³ / ₈	1	11

IBCO (Ferrule) (with Type A brass plug installed)

Part No.	Size	A	Tapping	Wt.
12108	2"	1¾	1½	1
12115	3"	1¾	2½	1
12122	4"	1¾	3½	2
12139	5"	1¾	4	6
12146	6"	1¾	5	7
12153	8"	2¼	6	10

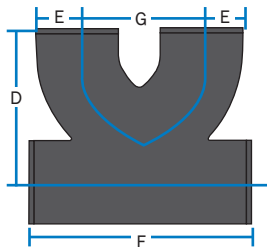

TEXAS TWIN CLEANOUT

Part No.	Size	D	E	F	G	Wt.
03004	4 x 4 x 4"	8¼	2¾	12	6½	19

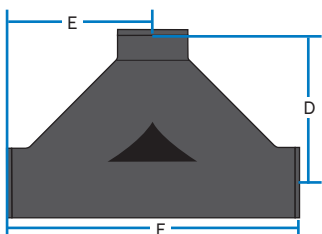

**TWO-WAY CLEANOUT FITTING
(Kelly)**

Part No.	Size	E	D	F	Wt.
08442	3 x 3 x 4"	7½	9	15	15
08446	4 x 4 x 4"	9¾	9½	18¾	26

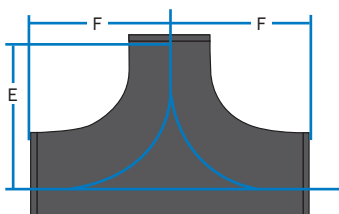

**TWIN CLEANOUT
(East Bay Code)**

Part No.	Size	F	E	Wt.
02990	4 x 4 x 4"	7½	7½	15

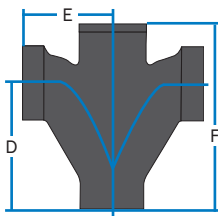

FIGURE 1

Part No.	Size	D	E	F	Wt.
08002	2 x 2 x 1½ x 1½"	4⅞	3¾	7	5

NO-HUB FITTINGS

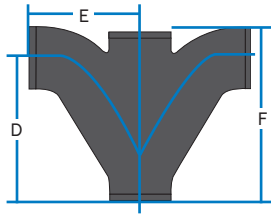

FIGURE 5

Part No.	Size	D	E	F	Wt.
08052	2"	6½	5	8	6
08054	3 x 2 x 3"	8⅞	6⅞	9¼	11
08056	3"	8⅞	6⅞	10⅛	11
08058	4 x 2 x 4"	10¼	7¾	11½	17
08062	4"	10¼	7¾	12	17

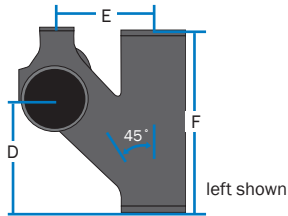

FIGURE 6 RIGHT/LEFT

Part No.	Size	D	E	F	Wt.
08100	3 x 2" RH	7⅞	5⅞	11	11
08102	3 x 2" LH	7⅞	5⅞	11	11
08104	4 x 2" LH	9	6½	13	18
08106	4 x 2" RH	9	6½	13	18

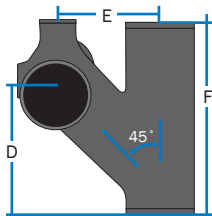

FIGURE 6 DOUBLE WITH FULL BAFFLE

Part No.	Size	D	E	F	Wt.
08127	3 x 2"	7⅞	5⅞	11	13
08112	4 x 2"	9	6½	13	23

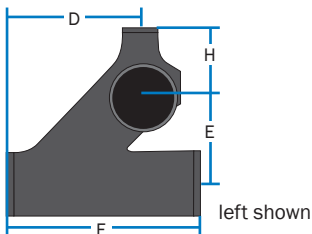

FIGURE 8 RIGHT/LEFT

Part No.	Size	D	E	F	H	Wt.
08136	3 x 2" RH	7 ⁹ / ₁₆	5 ¹ / ₁₆	11	3 ⁷ / ₁₆	13
08138	3 x 2" LH	7 ⁹ / ₁₆	5 ¹ / ₁₆	11	3 ⁷ / ₁₆	13
08140	4 x 2" RH	9	6 ¹ / ₂	13	4	21
08142	4 x 2" LH	9	6 ¹ / ₂	13	4	21

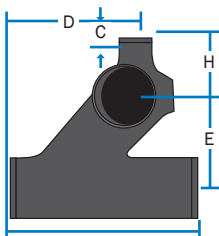
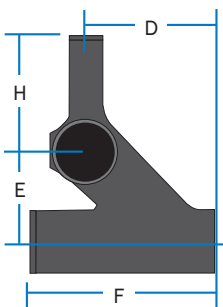

FIGURE 8 DOUBLE WITH FULL BAFFLE

Part No.	Size	D	E	F	C	H	Wt.
08159	3 x 2"	7 ⁹ / ₁₆	5 ¹ / ₁₆	11	4 ¹ / ₈	3 ⁷ / ₁₆	13



**FIGURE 8 DOUBLE EXTENDED
FULL BAFFLE**

Part No.	Size	H	D	E	F	C	Wt.
08163	4 x 2"	8	9	6 ¹ / ₂	13	4 ¹ / ₂	23

NO-HUB FITTINGS

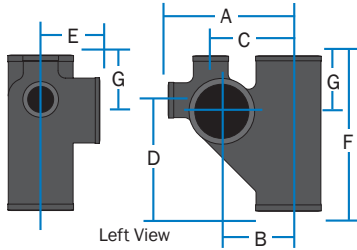

9-458 VENTED CLOSET TEE (RIGHT OR LEFT) (with 2" top vent and 2" side inlet)

Part No.	Size	A	B	C	D	E	F	G	Wt.
10494	4x4x2x2x4x4"RH	8 $\frac{3}{8}$	4 $\frac{1}{4}$	5 $\frac{1}{4}$	7 $\frac{1}{2}$	4	10 $\frac{1}{2}$	3 $\frac{3}{4}$	13
10500	4x4x2x2x4x4"LH	8 $\frac{3}{8}$	4 $\frac{1}{4}$	5 $\frac{1}{4}$	7 $\frac{1}{2}$	4	10 $\frac{1}{2}$	3 $\frac{3}{4}$	13

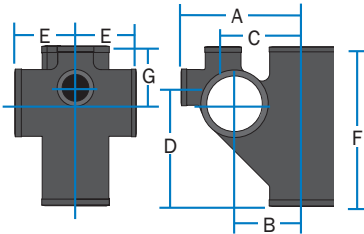

9-464 VENTED CLOSET CROSS (with 2" top vent and 2" side inlet, no baffle)

Part No.	Size	A	B	C	D	E	F	G	Wt.
10531	4x4x2x2x4x4"	8 $\frac{3}{8}$	4 $\frac{1}{4}$	5 $\frac{1}{4}$	7 $\frac{1}{2}$	4	10 $\frac{1}{2}$	3 $\frac{3}{4}$	16

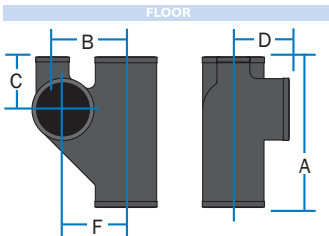

10" CLOSET FITTINGS WITH 2" TOP VENT DESIGNED TO BE USED BELOW THE FLOOR (left hand, right hand or double)

Part No.	Size	UPC# 611942	A	B	C	D	F	Wt.
10487 L	4"	9-457	10 $\frac{3}{4}$	6 $\frac{1}{2}$	3 $\frac{3}{4}$	4	4 $\frac{1}{2}$	13
10470 R	4"	9-457	10 $\frac{3}{4}$	6 $\frac{1}{2}$	3 $\frac{3}{4}$	4	4 $\frac{1}{2}$	13
10517**D	4"	9-463	10 $\frac{3}{4}$	6 $\frac{1}{2}$	3 $\frac{3}{4}$	4	4 $\frac{1}{2}$	15

When ordering please specify Left, Right or Double

**Double closet fitting has a baffle.

AB&I Foundry
800/GOT-IRON • ABIFoundry.com

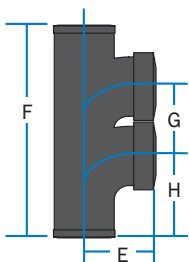

**DOUBLE VERTICAL
SANITARY TAPPED TEE**

Part No.	Size	E	F	G	H	Wt.
08194	2 x 1½"	2 ¹³ / ₁₆	9 ³ / ₄	4½	3¼	4

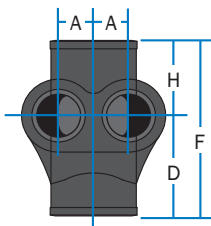

**HORIZONTAL TWIN SANITARY
TAPPED TEE**

Part No.	Size	A	D	F	H	Wt.
08170	3 x 1½"	1 ³ / ₈	4	7	3	8
08187	4 x 1½"	1 ³ / ₈	4	7	3	8

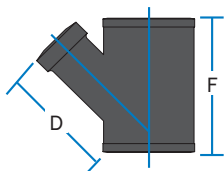

TAPPED WYE

Part No.	Size	D	F	Wt.
08460	2 x 1½"	5 ¹ / ₁₆	6 ⁵ / ₈	4
08477	2 x 2"	5 ¹ / ₁₆	6 ⁵ / ₈	5
08484	3 x 1½"	5 ³ / ₄	6 ⁵ / ₈	6
08491	3 x 2"	5 ¹³ / ₁₆	6 ⁵ / ₈	6
08514	4 x 1½"	6 ⁷ / ₁₆	6 ⁵ / ₈	6
08521	4 x 2"	6½	6 ⁵ / ₈	8

NO-HUB SPECIAL FITTINGS

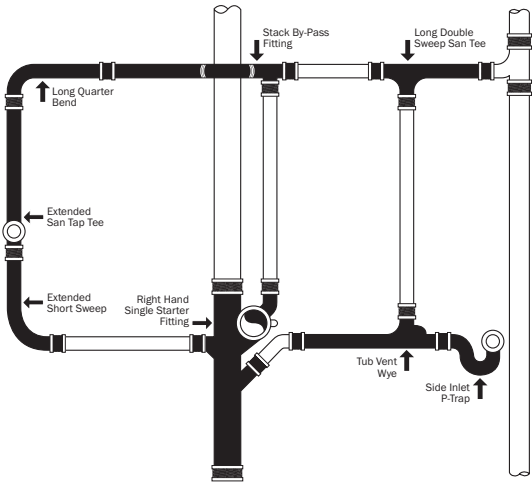

RUFWALL SAVINGS WITH BACK OUTLET FIXTURES (compared with conventional piping)

- Fewer floor penetrations
- Eliminates cost of dropped ceilings to conceal pipe
- No scaffolding needed
- One-man installation
- Waist-high venting
- Water closet easier to install...faster

NOTE:

Rufwall fittings are sold and shipped as normal cataloged soil products. This publication contains the information needed to place orders with your customer service representative.



NO-HUB SPECIAL FITTINGS

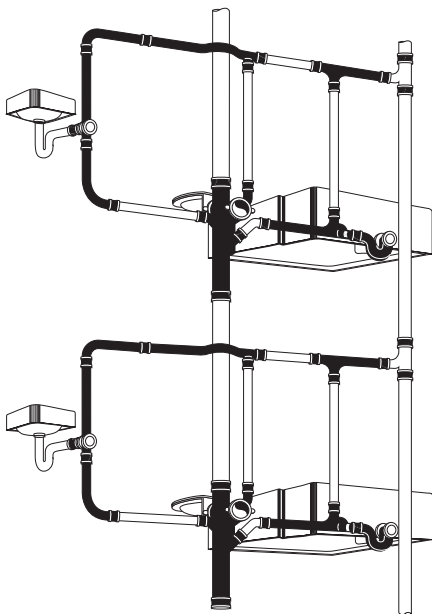

The **by-pass fitting** permits in-line piping to reduce width of the chase, and individual venting of the lavatories.

Tub wye fittings accept waste from two tubs and provide a common vent. They save space, materials and the labor to install duplicate systems.

NOTE:

Rufwall fittings are sold and shipped as normal cataloged soil products. This publication contains the information needed to place orders with your customer service representative.

STARTER FITTINGS

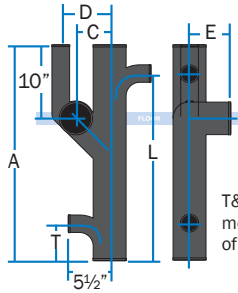

NEW YORK VERTICAL STACK STARTER FITTINGS (long barrel) EZS 400

Part No.	Size	A	L	C	D	E	T	Wt.
LEFT								
19527	4x30"	30	0	4½	6½	5½	0	34
90404	4x30"	30	6½	4½	6½	5½	0	35
19572	4x30"	30	12	4½	6½	5½	0	38
19497	4x30"	30	26½	4½	6½	5½	0	35
90381	4x30"	30	0	4½	6½	5½	4	34
90428	4x30"	30	26½	4½	6½	5½	4	34
90435	4x30"	30	26½	4½	6½	5½	4	34
90398	4x30"	30	0	4½	6½	5½	6½	34
90411	4x30"	30	6½	4½	6½	5½	6½	34
19466	4x30"	30	0	4½	6½	5½	12	31
19374	4x30"	30	26½	4½	6½	5½	12	30
RIGHT								
19510	4x30"	30	0	4½	6½	5½	0	33
90343	4x30"	30	6½	4½	6½	5½	0	35
19602	4x30"	30	12	4½	6½	5½	0	38
19480	4x30"	30	26½	4½	6½	5½	0	34
90329	4x30"	30	0	4½	6½	5½	4	34
90367	4x30"	30	26½	4½	6½	5½	4	29
90336	4x30"	30	0	4½	6½	5½	6½	34
90350	4x30"	30	6½	4½	6½	5½	6½	36
90374	4x30"	30	26½	4½	6½	5½	6½	36
19459	4x30"	30	0	4½	6½	5½	12	31
19367	4x30"	30	26½	4½	6½	5½	12	29
DOUBLE								
19534	4x30"	30	0	4½	6½	5½	0	30
90282	4x30"	30	6½	4½	6½	5½	0	37
19589	4x30"	30	12	4½	6½	5½	0	40
90268	4x30"	30	0	4½	6½	5½	4	38
90275	4x30"	30	0	4½	6½	5½	6½	36
90312	4x30"	30	26½	4½	6½	5½	6½	39
19473	4x30"	30	0	4½	6½	5½	12	36
19381	4x30"	30	26½	4½	6½	5½	12	39

*When ordering please specify Left, Right or Double.

AB&I Foundry
800/GOT-IRON • ABIFoundry.com

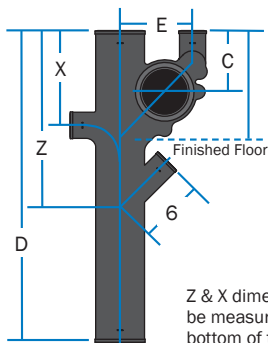

Z & X dimensions must be measured from the bottom of the fitting.

9-471 NO-HUB STARTER FITTING WITH OR WITHOUT 2" NO-HUB INLETS
(DESIGNED FOR USE ABOVE THE FLOOR WITH BACK-OUTLET WATER CLOSETS)
(left hand, right hand or double)

Part No.	Size	Z	X	C	D	E	Wt.	EZS
LEFT								
21384 L	4 x 28"	16	0	5½	28	6½	30	810
21407 L	4 x 28"	16	8½	5½	28	6½	30	810
21339 L	4 x 28"	-	-	5½	28	6½	29	710
21353 L	4 x 28"	-	8½	5½	28	6½	32	710
RIGHT								
21391 R	4 x 28"	16	0	5½	28	6½	30	810
21414 R	4 x 28"	16	8½	5½	28	6½	30	810
21346 R	4 x 28"	-	-	5½	28	6½	29	710
21360 R	4 x 28"	-	8½	5½	28	6½	31	710
DOUBLE								
21322*D	4 x 28"	16	0	5½	28	6½	33	810
97598*D	4 x 28"	16	8½	5½	28	6½	38	810
21292*D	4 x 28"	-	-	5½	28	6½	32	710
21308*D	4 x 28"	-	8½	5½	28	6½	33	710

Trim package not included in price of fitting.

*Double starter fitting has a baffle.

STARTER FITTINGS

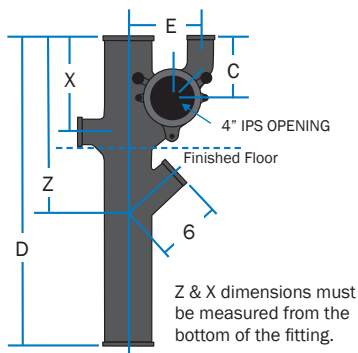

**9-371 THREADED STARTER FITTING
WITH OR WITHOUT NO-HUB INLETS
(DESIGNED FOR USE ABOVE THE FLOOR
WITH BACK-OUTLET WATER CLOSETS)
(left hand, right hand or double)**

Part No.	Size	Z	X	C	D	E	Wt.	EZS
LEFT								
76149 L	4 x 28"	16	0	5½	28	6½	27	800
76163 L	4 x 28"	16	8½	5½	28	6½	29	800
76101 L	4 x 28"	-	-	5½	28	6½	29	700
76125 L	4 x 28"	-	8½	5½	28	6½	30	700
RIGHT								
76132 R	4 x 28"	16	0	5½	28	6½	36	800
76156 R	4 x 28"	16	8½	5½	28	6½	36	800
76095 R	4 x 28"	-	-	5½	28	6½	29	700
76118 R	4 x 28"	-	8½	5½	28	6½	30	700
DOUBLE								
76088*D	4 x 28"	16	0	5½	28	6½	42	800
76057*D	4 x 28"	16	8½	5½	28	6½	42	800
76071*D	4 x 28"	-	-	5½	28	6½	35	700
76064*D	4 x 28"	-	8½	5½	28	6½	36	700

Trim package not included in price of fitting.

*Double starter fitting has a baffle.

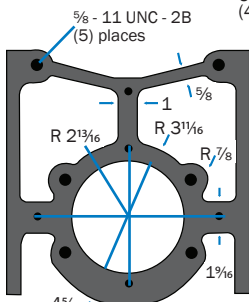
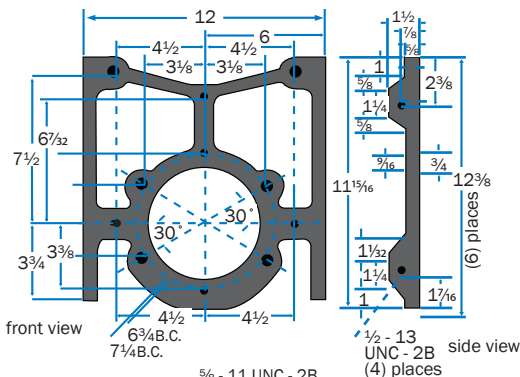
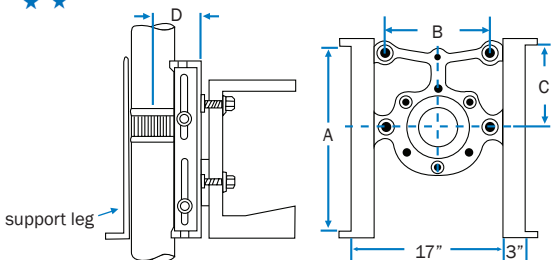

**EZS 22 EXTENDED LEG
(left or right)**

EZS 22 SUPPORT LEG

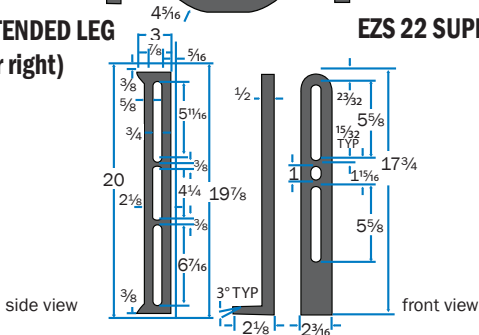

TRIM PACKAGE FOR STARTER FITTINGS

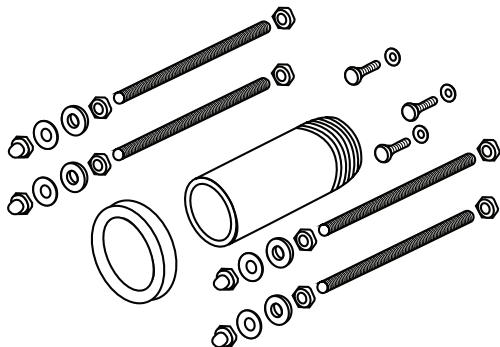

EZS 22 AND EZS 24 INSTALLATION INSTRUCTIONS

1. IDENTIFY THE MAJOR COMPONENTS OF THE EZS 24 TRIM PACKAGE AND EZS 22 SUPPORT FRAME.
2. SECURE EZS 22 SUPPORT FRAME TO INSTALLED STARTER FITTING USING $\frac{3}{8}$ " X $1\frac{1}{2}$ " BOLTS AND $\frac{3}{8}$ " FLAT WASHERS.
3. SECURE RIGHT AND LEFT LEGS TO THE EZS 22 FACEPLATE USING $\frac{1}{2}$ " X $1\frac{1}{4}$ " BOLTS AND $\frac{1}{2}$ " FLAT WASHERS IN POSITION SHOWN TO THE RIGHT.
4. ADJUST ASSEMBLY TO THE DESIRED HEIGHT. LEVEL AND ALIGN THE ASSEMBLY.
5. SECURE THE FEET OF THE EZS 22 SUPPORT FRAME TO THE FLOOR USING THE $\frac{1}{2}$ " X $1\frac{1}{4}$ " BOLTS SUPPLIED.
6. SECURE SUPPORT LEG. FOR DOUBLE STARTER FITTINGS, THE SUPPORT LEG IS NOT REQUIRED.
7. SECURE $\frac{5}{8}$ " X 12" EZS 24 THREAD RODS TO FACEPLATE ACCORDING TO EZS 22 FACEPLATE.
8. INSTALL EZS 24 THREADED NIPPLE TO THE EZS 700 OR EZS 800 FITTING.

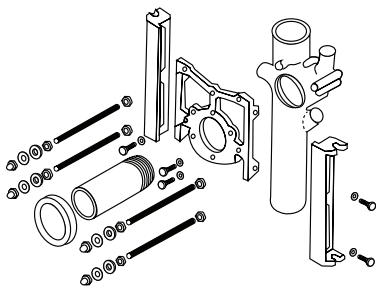

EZS 23

Part No.: 76045

**TRIM PACKAGE, FLOOR-MOUNTED BACK-OUTLET ASSEMBLY
(note: not to be used with PART NO. EZS 22 support frame assembly)**

- 1 – 4" PVC Sch. 80 NIPPLE with TEST CAP
- 1 – BOWL GASKET
- 2 – 5/16" X 12" RODS
- 2 – 5/16" HEX NUTS
- 2 – 5/16" FLAT WASHERS
- 2 – 5/16" CAP NUTS

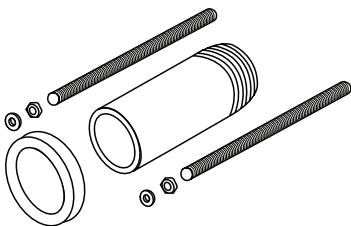

EZS 24

Part No.: 76050

**TRIM PACKAGE, WALL-HUNG BACK-OUTLET ASSEMBLY
(to be used with PART NO. EZS 22 support frame assembly)**

- 1 – 4" PVC Sch. 80 NIPPLE with TEST CAP
- 1 – BOWL GASKET
- 4 – 5/8" X 12" RODS
- 4 – 5/8" CHROME CAP NUTS
- 8 – 5/8" JAM NUTS
- 4 – 5/8" FLAT WASHERS
- 4 – 5/8" FIBER WASHERS
- 3 – 3/8" X 1 1/2" BOLTS FOR FACEPLATE
- 3 – 3/8" FLAT WASHERS
- 4 – 5/8" STAR WASHERS

**CLOSET BENDS**

Part No.	Size	Wt.
02892	4 x 4 x 12"	11
02896	4 x 4 x 14"	11
02894	4 x 4 x 16"	15
02898	4 x 4 x 18"	13
02904	4 x 6 x 12"	11
02908	4 x 6 x 15"	15
02914	4 x 6 x 16"	13
02912	4 x 6 x 18"	16
02924	4 x 10 x 12"	16
02932	4 x 10 x 15"	17
02934	4 x 10 x 16"	16
02936	4 x 10 x 18"	19
02938	4 x 12 x 12"	12
02940	4 x 12 x 14"	18
02944	4 x 12 x 16"	20
02946	4 x 12 x 18"	24
02950	4 x 16 x 16"	23
02954	4 x 18 x 18"	25

**CLOSET BENDS
(reducing)**

Part No.	Size	Wt.
02832	3 x 4 x 6 x 12"	10
02840	3 x 4 x 6 x 15"	10
02844	3 x 4 x 6 x 18"	13
02852	3 x 4 x 10 x 12"	12
02860	3 x 4 x 10 x 15"	16
02864	3 x 4 x 10 x 18"	16
02866	3 x 4 x 12 x 12"	16
02870	3 x 4 x 16 x 16"	18
02872	3 x 4 x 18 x 18"	25

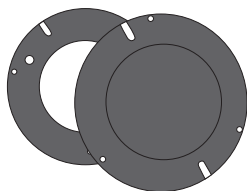

BEST-SET™ CLOSET RING

Part No.	Size	Box Qty	Wt.
08020	4 x 2" (with test cap)	12	3
08021	4 x 2"	12	3
08022	4 x 4"	8	4
08023	4 x 4" (with test cap)	8	4
08024	4 x 3" (with test cap)	12	3

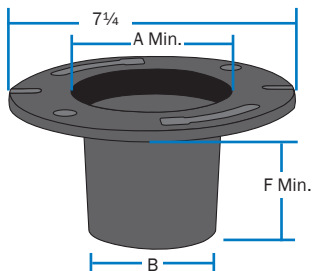

CLOSET RINGS (No-Hub)

Part No.	Size	A	B	F	Wt.
02966	4 x 3 x 3 1/2"	4	3	3 1/2	4
02970	4 x 4"	4	4	4	5

Used with no-hub coupling

NO-HUB FITTINGS

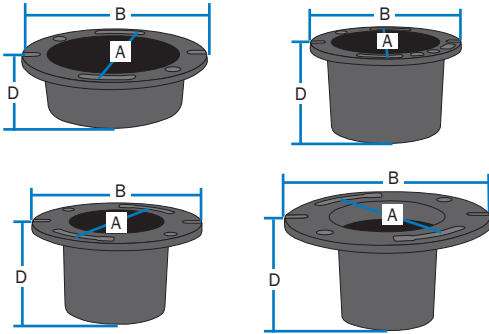

2-252 CLOSET FLANGE (Caulk Joint Application)

Part No.	Size x Height	A	B	D	Wt.
022848	4 x 1"	6 $\frac{1}{4}$	7 $\frac{1}{4}$	1	2
022855	4 x 1 $\frac{1}{2}$ "	6 $\frac{1}{4}$	7 $\frac{1}{4}$	1 $\frac{1}{2}$	2
8003	4 x 2"	6 $\frac{1}{4}$	7 $\frac{1}{4}$	2	2
8013*	4 x 2"	6 $\frac{3}{8}$	7 $\frac{1}{4}$	2	2.8
022879	4 x 2 $\frac{1}{2}$ "	6 $\frac{1}{4}$	7 $\frac{1}{4}$	2 $\frac{1}{2}$	3
022886	4 x 3"	6 $\frac{1}{4}$	7 $\frac{1}{4}$	3	4
8005	4 x 4"	6 $\frac{1}{4}$	7 $\frac{1}{4}$	4	5
022930*	4 x 4"	6 $\frac{1}{8}$	7 $\frac{1}{4}$	4	5
022909	4 x 5"	6 $\frac{1}{4}$	7 $\frac{1}{4}$	5	6
8017	4 x 6"	6 $\frac{1}{4}$	7 $\frac{1}{4}$	6	6
8015	4 x 2", 1" Offset	6	7	2	2.5
8018	4 x 4", 2" Offset	6 $\frac{1}{4}$	7 $\frac{1}{4}$	4	4.5
022947	4 x 3", 3" Reducing	6 $\frac{1}{4}$	7 $\frac{1}{4}$	3	3
8007	4 x 2"	6 $\frac{1}{4}$	7 $\frac{1}{4}$	2	3
8011	4 x 4 x 4"	6 $\frac{1}{4}$	7 $\frac{1}{4}$	4	4
8019	4 x 3 x 2 $\frac{1}{2}$ "	6 $\frac{1}{4}$	7 $\frac{1}{4}$	2 $\frac{1}{2}$	3

*Portland Code, two $\frac{1}{4}$ " taps on top.



QUALITY SV HUB & SPIGOT PIPE

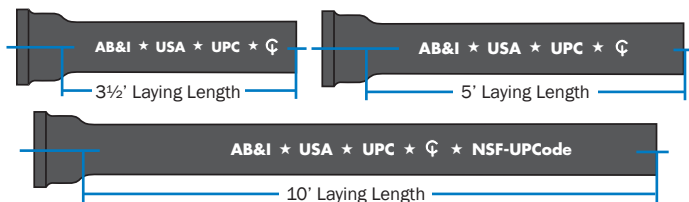

SV SINGLE HUB PIPE

3½ Ft.	Part No.	Size	Pcs/ Pkg	Unit Wt.
	244059	2"	102	15
	244066	3"	60	23
	244073	4"	46	30
	244080	5"	32	38
	244097	6"	24	45
	000273	8"	15	78
	000280	10"	8	116
	000297	12"	6	145
	000303	15"	3	205

5 Ft.	Part No.	Size	Pcs/ Pkg	Unit Wt.
	000006	2"	102	20
	000013	3"	60	31
	000020	4"	46	42
	000037	5"	32	55
	000044	6"	24	62
	000051	8"	15	100
	000068	10"	8	150
	000075	12"	6	190
	000082	15"	3	260

10 Ft.	Part No.	Size	Pcs/ Pkg	Unit Wt.
	000181	2"	36	38
	000198	3"	36	52
	000204	4"	27	76
	000211	5"	24	97
	000228	6"	18	120
	000235	8"	15	190
	000242	10"	8	270
	000259	12"	6	355
	000266	15"	3	515

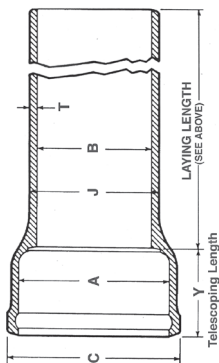

SV SINGLE HUB PIPE

Size	Telescoping Length		Hub		Hub		Barrel		Barrel		Nominal Thickness	Minimum Thickness
	Y	J	A	I.D.	C	O.D.	J	O.D.	B	I.D.	T	T
2"	2.50		2.94		3.62	2.30	2.30		1.96		0.17	0.14
3"	2.75		3.94		4.68	3.30	3.30		2.96		0.17	0.14
4"	3.00		4.94		5.68	4.30	4.30		3.94		0.18	0.15
5"	3.00		5.94		6.68	5.30	5.30		4.94		0.18	0.15
6"	3.00		6.94		7.68	6.30	6.30		5.94		0.18	0.15
8"	3.50		9.25		10.13	8.40	8.40		7.94		0.23	0.17
10"	3.50		11.38		12.44	10.50	10.50		9.94		0.28	0.22
12"	4.25		13.50		14.56	12.50	12.50		11.94		0.28	0.22
15"	4.25		16.95		18.11	15.88	15.88		15.16		0.36	0.30



DOUBLE HUB, 30" LENGTHS

Part No.	Size	L	Pcs/Pkg	Wt.
000310	2"	25"	140	12
000327	3"	24½"	80	17
000334	4"	24"	50	26



PIPE, 5' LENGTHS, DOUBLE HUB

Part No.	Size	L	Wt.
400864	2" x 5'	4' 9½"	22
400865	3" x 5'	4' 9¼"	32
400866	4" x 5'	4' 9"	43
400867	5" x 5'	4' 9"	58
400868	6" x 5'	4' 9"	70

SV HUB & SPIGOT FITTINGS

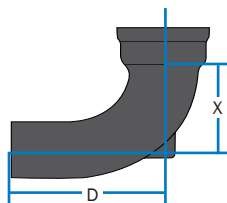

1/4 BEND

Part No.	Size	X	D	Wt.
000341	2"	3 ¹ / ₄	6	4
000358	3"	4	7	6
000365	4"	4 ¹ / ₂	8	11
000372	5"	5	8 ¹ / ₂	17
000389	6"	5 ¹ / ₂	9	20
000396	8"	6 ⁵ / ₈	11 ¹ / ₂	41
000402	10"	7 ⁵ / ₈	12 ¹ / ₂	59
000419	12"	8 ³ / ₄	15	79
000426*	15"	10 ¹ / ₄	16 ¹ / ₂	218

*XH only

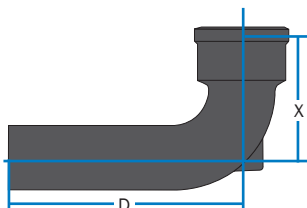

LONG 1/4 BEND

Part No.	Size	X	D	Wt.
000792	2 x 12"	3 ¹ / ₄	12	7
000808	2 x 18"	3 ¹ / ₄	18	8
000815	3 x 12"	4	12	11
000839	4 x 12"	4 ¹ / ₂	12	16
000860	4 x 18"	4 ¹ / ₂	18	22
000877	4 x 24"	4 ¹ / ₂	24	28



SV HUB & SPIGOT FITTINGS

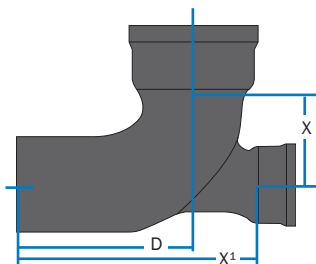

1/4 BEND WITH LOW HEEL INLET

Part No.	Size	X	X'	D	Wt.
000716	3 x 2"	4	9	7	9
000723	4 x 2"	4½	10½	8	13

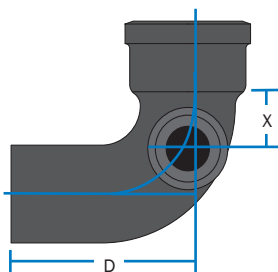

1/4 BEND WITH SIDE INLET (cup hub inlet)

Part No.	Size	D	X	Wt.
047698	4" w/2" RH	8	4½	17
047704	4" w/2" LH	8	4½	17

SV HUB & SPIGOT FITTINGS

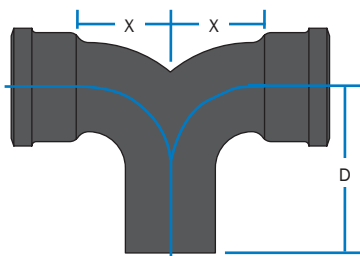

DOUBLE 1/4 BEND

Part No.	Size	D	X	Wt.
392002	4"	8	4½	15

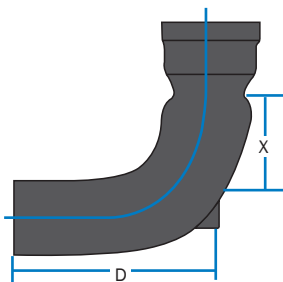

1/4 BEND, REDUCING

Part No.	Size	X	D	Wt.
100089	3 x 2"	3¾	7	7
000747	4 x 2"	3½	7	12
000754	4 x 3"	4¼	8⅞	10

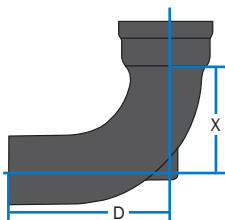

SHORT SWEEP 1/4 BEND

Part No.	Size	X	D	Wt.
001102	2"	5 $\frac{1}{4}$	8	6
001119	3"	6	9	9
001126	4"	6 $\frac{1}{2}$	10	13
001133	5"	7	10 $\frac{1}{2}$	16
001140	6"	7 $\frac{1}{2}$	11	20
001157	8"	8 $\frac{5}{8}$	13 $\frac{1}{2}$	48
001164	10"	9 $\frac{5}{8}$	14 $\frac{1}{2}$	78
001171	12"	10 $\frac{3}{4}$	17	101

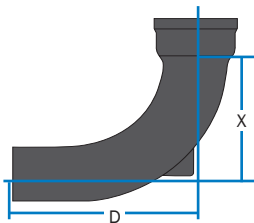

LONG SWEEP 1/4 BEND

Part No.	Size	X	D	Wt.
001041	2"	8 $\frac{1}{4}$	11	7
001058	3"	9	12	11
001065	4"	9 $\frac{1}{2}$	13	16
001072	5"	10	13 $\frac{1}{2}$	20
001089	6"	10 $\frac{1}{2}$	14	30
001096	8"	11 $\frac{5}{8}$	16 $\frac{1}{2}$	54
382638	10"	12 $\frac{5}{8}$	17 $\frac{1}{2}$	83
383581	12"	13 $\frac{3}{4}$	20	104
393016*	15"	15 $\frac{1}{4}$	21 $\frac{1}{2}$	174

*XH Only

HUB & SPIGOT FITTINGS

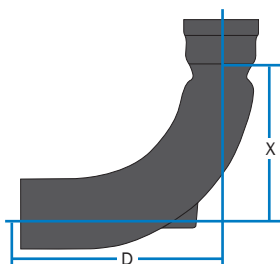

LONG SWEEP $\frac{1}{4}$ BEND, REDUCING

Part No.	Size	X	D	Wt.
001188	3 x 2"	9	12	11
001195	4 x 3"	9½	13	13

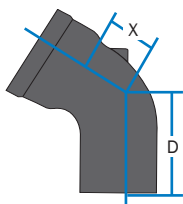

$\frac{1}{6}$ BEND

Part No.	Size	X	D	Wt.
000464	2"	2	4¾	4
000471	3"	2½	5½	6
000488	4"	2 ¹³ / ₂₆	6 ⁵ / ₁₆	10
383116	5"	3 ¹ / ₈	6 ⁵ / ₈	14
000495	6"	3 ³ / ₈	6 ⁷ / ₈	17
328536	8"	4 ¹ / ₈	9	33
000501	10"	4 ¹¹ / ₁₆	9 ⁹ / ₁₆	44

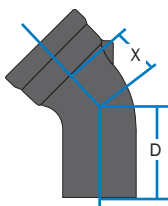

1/8 BEND

Part No.	Size	X	D	Wt.
000518	2"	1½	4¼	4
000525	3"	1 ¹⁵ / ₁₆	4 ¹⁵ / ₁₆	6
000532	4"	2 ³ / ₁₆	5 ¹¹ / ₁₆	9
000549	5"	2 ³ / ₈	5 ⁷ / ₈	11
000556	6"	2 ⁹ / ₁₆	6 ¹ / ₁₆	13
000563	8"	3 ¹ / ₈	8	34
000570	10"	3½	8 ³ / ₈	50
000587	12"	4 ¹ / ₁₆	10 ⁵ / ₁₆	69
000594*	15"	4 ¹ / ₁₆	10 ¹⁵ / ₁₆	144

*XH only



LONG 1/8 BEND

Part No.	Size	X	D	Wt.
000983	3 x 12"	1 ¹⁵ / ₁₆	12	10
000990	3 x 18"	1 ¹⁵ / ₁₆	18	12
001003	4 x 12"	2 ³ / ₁₆	12	16
001010	4 x 18"	2 ³ / ₁₆	18	18
393023	6 x 18"	2 ⁹ / ₁₆	18	31

SV HUB & SPIGOT FITTINGS

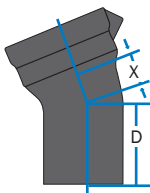

1/16 BEND

Part No.	Size	X	D	Wt.
000600	2"	7/8	3 5/8	3
000617	3"	1 3/16	4 3/16	6
000624	4"	1 5/16	4 13/16	8
000631	5"	1 3/8	4 7/8	12
000648	6"	1 1/2	5	12
000655	8"	1 13/16	6 1/16	25
000662	10"	2	6 7/8	39
000679	12"	2 3/8	8 5/8	62
000686*	15"	2 5/8	8 7/8	78

*XH only

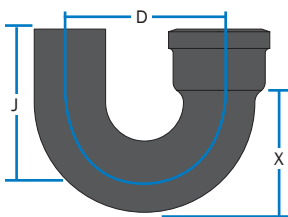

SINGLE HUB RETURN BEND

Part No.	Size	X	D	J	Wt.
001027	3"	5	5 5/8	5 7/8	10
001034	4"	6 1/30	7 1/2	7 3/16	17



SV HUB & SPIGOT FITTINGS

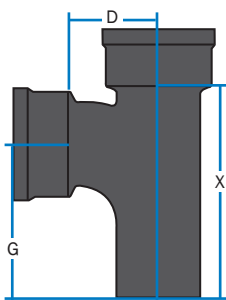

SANITARY TEE

Part No.	Size	X	E	G	Wt.
001287	2"	8	2 ³ / ₄	6 ¹ / ₄	7
001294	3 x 2"	9	4	7	11
001300	3"	10	4	7 ¹ / ₂	11
001317	4 x 2"	9	4 ¹ / ₂	7	13
001324	4 x 3"	10	4 ¹ / ₂	7 ¹ / ₂	15
001331	4"	11	4 ¹ / ₂	8	17
001348	5 x 4"	11	5	8	18
001355	5"	12	5	8 ¹ / ₂	19
001362	6 x 2"	9	5 ¹ / ₂	7	17
001379	6 x 3"	10	5 ¹ / ₂	7 ¹ / ₂	19
001386	6 x 4"	11	5 ¹ / ₂	8	24
001393	6"	13	5 ¹ / ₂	9	29
001409	8 x 4"	13	6 ¹ / ₂	9 ³ / ₄	38
001416	8 x 6"	15	6 ¹ / ₂	10 ³ / ₄	40
001423	8"	17	6 ⁵ / ₈	11 ³ / ₄	49
001430	10 x 4"	13	7 ¹ / ₂	9 ³ / ₄	50
001447	10 x 6"	15	7 ¹ / ₂	10 ³ / ₄	59
001454	10 x 8"	17	7 ⁵ / ₈	11 ³ / ₄	68
001461	10"	19	7 ⁵ / ₈	12 ³ / ₄	78
001478	12 x 6"	16 ¹ / ₂	8 ¹ / ₂	12	79
001485	12 x 8"	18 ¹ / ₂	8 ⁵ / ₈	13	111
001492	12 x 10"	20 ¹ / ₂	8 ⁵ / ₈	14	123
001508	12"	22 ¹ / ₂	8 ³ / ₄	15	113
001553*	15"	25 ¹ / ₂	10 ¹ / ₄	16 ¹ / ₂	245
001522	15 x 8"	18 ¹ / ₂	10 ¹ / ₈	13	180

*XH only

SV HUB & SPIGOT FITTINGS

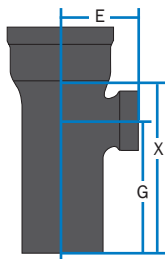

SANITARY TAPPED TEE

Part No.	Size	X	E	G	Wt.
003137	2 x 1½"	8	2 ¹³ / ₁₆	6¼	6
003144	2 x 2"	8	3 ¹ / ₆	6¼	7
003168	3 x 1½"	9	3 ⁵ / ₁₆	7	8
003175	3 x 2"	9	3 ⁹ / ₁₆	7	9
003182	3 x 3"	10	3 ⁵ / ₁₆	7¼	11
003205	4 x 1½"	9	3 ¹³ / ₁₆	7	11
003212	4 x 2"	9	4 ¹ / ₁₆	7	13
399247	4 x 3"	11	3 ¹⁵ / ₁₆	8	14

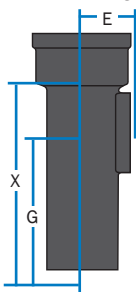

STRAIGHT TAPPED TEE

Part No.	Size	X	E	G	Wt.
002963	2 x 1½"	8	2	6¼	6
002970*	2 x 2"	8	2	6¼	6
002994	3 x 1½"	9	2½	7	8
003007	3 x 2"	9	2½	7	8
003045	4 x 2"	9	3	7	11
392071	4 x 3"	11	3	8	14
003076	5 x 2"	12	3½	7 ⁷ / ₈	13
003083	5 x 4"	12	3½	8½	15
003090	6 x 2"	13¼	3 ⁵ / ₈	9	26
003106	6 x 4"	13	4	9	25

*#002970 (2") is the same as the Test Tee Less Plug

SV HUB & SPIGOT FITTINGS

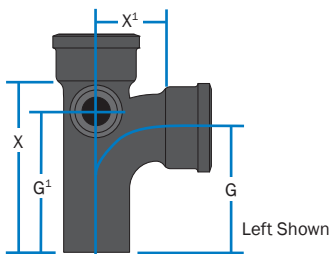

SANITARY TEE WITH SIDE TAP

Part No.	Size	G	G ¹	X	X ¹	Wt.
002369	4" w/2" RH Tap	8	9	11	4½	17
002376	4" w/2" LH Tap	8	9	11	4½	17

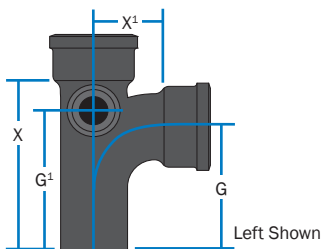

SANITARY TEE WITH SIDE INLET

Part No.	Size	G	G ¹	X	X ¹	Wt.
002284	4" w/2" RH	8	9	11	4½	20
002307	4" w/2" LH	8	9	11	4½	20

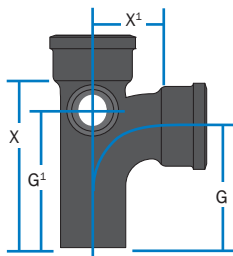

SANITARY TEE WITH RIGHT AND LEFT HAND SIDE TAPS

Part No.	Size	G	G ¹	X	X ¹	Wt.
002383	4" w/2"	8	9	11	4½	17

SV HUB & SPIGOT FITTINGS

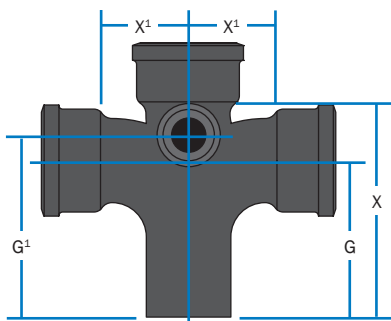

**SANITARY CROSS WITH
2" SIDE OPENING**

Part No.	Size	G	G ¹	X	X ¹	Wt.
002871	4"	8	9	11	4½	27

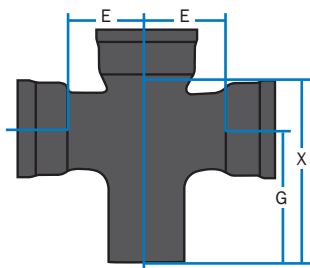

**SANITARY CROSS
(No Baffle)**

Part No.	Size	X	E	G	Wt.
002512	2"	8	3¼	6¼	9
002529	3 x 2"	9	4	7	13
002536	3"	10	4	7½	15
002543	4 x 2"	9	4½	7	15
002550	4 x 3"	10	4½	7½	18
002567	4"	11	4½	8	19
002574	5 x 4"	11	5	8	23
383321	6"	13	5½	9	44
102618	6 x 4"	11	5½	8	29

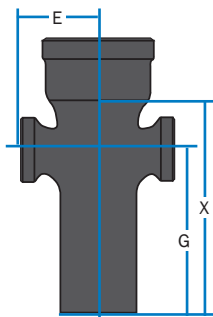

TAPPED SANITARY CROSS

Part No.	Size x Tap	X	E	G	Wt.
003359	2 x 1½"	8	4¼	6¼	8
003366	2 x 2"	8	4¼	6¼	8
003397	3 x 2"	9	4¼	7	10
003410	4 x 1½"	9	5	7	12
003427	4 x 2"	9	5	7	12

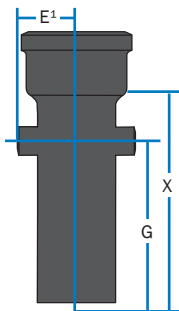

STRAIGHT TAPPED CROSS

Part No.	Size	X	E	G	Wt.
003311	3 x 2"	9	2½	7	10
003328	4 x 2"	9	3	7	14

SV HUB & SPIGOT FITTINGS

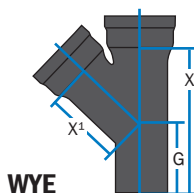

Part No.	Size	X	X'	G	Wt.
001560	2"	8	4	4	8
001577	3 x 2"	9	5	4 ³ / ₁₆	9
001584	3"	10 ¹ / ₂	5 ¹ / ₂	5	14
001591	4 x 2"	9	5 ³ / ₄	3 ⁵ / ₈	13
001607	4 x 3"	10 ¹ / ₂	6 ¹ / ₄	4 ⁷ / ₁₆	18
001614	4"	12	6 ³ / ₄	5 ¹ / ₄	18
001621	5 x 2"	9	6 ¹ / ₂	3 ¹ / ₈	14
001638	5 x 3"	10 ¹ / ₂	7	3 ⁷ / ₈	17
001645	5 x 4"	12	7 ¹ / ₂	4 ¹¹ / ₁₆	19
001652	5"	13 ¹ / ₂	8	5 ¹ / ₂	23
001669	6 x 2"	9	7 ¹ / ₄	2 ⁹ / ₁₆	17
001676	6 x 3"	10 ¹ / ₂	7 ³ / ₄	3 ³ / ₈	17
001683	6 x 4"	12	8 ¹ / ₄	4 ³ / ₁₆	21
001690	6 x 5"	13 ¹ / ₄	8 ³ / ₄	4 ¹⁵ / ₁₆	31
001706	6"	15	9 ¹ / ₄	5 ³ / ₄	36
383482	8 x 2"	10 ¹ / ₂	8 ¹ / ₂	3 ¹ / ₈	31
387848	8 x 3"	12	9	3 ¹⁵ / ₁₆	33
001713	8 x 4"	13 ¹ / ₂	9 ¹ / ₂	4 ³ / ₄	45
001720	8 x 5"	15	10	5 ¹ / ₂	46
001737	8 x 6"	16 ¹ / ₂	10 ¹ / ₂	6 ⁵ / ₁₆	53
001744	8"	19 ¹ / ₂	11 ¹³ / ₁₆	7 ¹¹ / ₁₆	65
001751	10 x 3"	12	10 ³ / ₄	2 ³ / ₄	56
001768	10 x 4"	13 ¹ / ₂	11 ¹ / ₈	3 ⁹ / ₁₆	64
001775	10 x 5"	15	11 ⁵ / ₈	4 ⁵ / ₁₆	65
001782	10 x 6"	16 ¹ / ₂	12 ¹ / ₂	5 ¹ / ₈	76
001799	10 x 8"	19 ¹ / ₂	13 ⁷ / ₁₆	6 ¹ / ₂	85
001805	10"	22 ¹ / ₂	14 ¹ / ₂	8	107
001812	12 x 4"	15	12 ⁷ / ₁₆	4 ¹ / ₈	76
001829	12 x 5"	16 ¹ / ₂	12 ¹⁵ / ₁₆	4 ⁷ / ₈	75
001836	12 x 6"	18	13 ⁷ / ₁₆	5 ¹¹ / ₁₆	84
001843	12 x 8"	21	14 ³ / ₄	7 ¹ / ₁₆	110
001850	12 x 10"	24	15 ¹³ / ₁₆	8 ⁹ / ₁₆	159
001867	12"	27	16 ⁷ / ₈	10 ¹ / ₈	189
001874	15 x 4"	15 ¹ / ₄	15	2 ¹ / ₂	138
001881	15 x 6"	18	15 ³ / ₄	4	171
001898	15 x 8"	21	17 ¹ / ₁₆	5 ³ / ₈	207
001904	15 x 10"	24	18 ¹ / ₈	6 ⁷ / ₈	213
001911	15 x 12"	27	19 ³ / ₁₆	8 ⁷ / ₁₆	242
001928*	15"	31 ¹ / ₂	20 ³ / ₄	10 ³ / ₄	333

*XH only

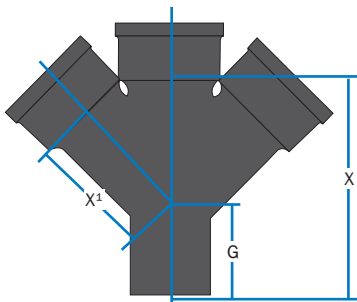

DOUBLE WYE

Part No.	Size	X	X'	G	Wt.
002598	2"	8	4	4	9
002604	3 x 2"	9	5	4 ³ / ₁₆	13
002611	3"	10 ¹ / ₂	5 ¹ / ₂	5	16
002628	4 x 2"	9	5 ³ / ₄	3 ⁵ / ₈	15
002635	4 x 3"	10 ¹ / ₂	6 ¹ / ₄	4 ⁷ / ₁₆	19
002642	4"	12	9 ¹ / ₄	5 ¹ / ₄	23
392026	5"	13 ¹ / ₂	8	5 ¹ / ₂	27
387855	6 x 3"	10 ¹ / ₂	7	3 ⁵ / ₈	23
002659	6 x 4"	12	8 ¹ / ₄	4 ³ / ₁₆	32
002666	6"	15	9 ¹ / ₄	5 ³ / ₄	45
002673	8 x 4"	13 ¹ / ₂	9 ¹ / ₂	4 ³ / ₄	50
002680	8 x 6"	16 ¹ / ₂	10 ¹ / ₂	6 ⁵ / ₁₆	64
002697	8"	19 ¹ / ₂	11 ¹³ / ₁₆	7 ¹¹ / ₁₆	90
383086	10 x 6"	19 ¹ / ₂	12 ¹ / ₂	6 ¹ / ₂	81
002703	10 x 8"	19 ¹ / ₂	13 ⁷ / ₁₆	6 ¹ / ₂	114
002710	10"	22 ¹ / ₂	14 ¹ / ₂	8	120
002727	12 x 8"	21	14 ³ / ₄	7 ¹ / ₁₆	136
002734	12"	27	16 ⁷ / ₈	10 ¹ / ₈	175
002741*	15"	31 ¹ / ₂	20 ³ / ₄	10 ³ / ₄	354

*XH only

SV HUB & SPIGOT FITTINGS

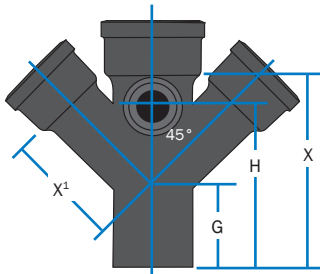

**DOUBLE WYE WITH 2" SIDE OPENING
(cup hub inlet)**

Part No.	Size	G	H	X	X ¹	Wt.
002932	4"	5¼	10	12	6¾	32

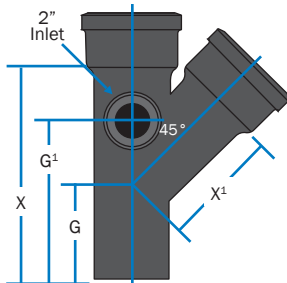

**WYE WITH LEFT HAND SIDE INLET
(cup hub inlet)**

Part No.	Size	G	G ¹	X	X ¹	Wt.
002406	4" w/ 2"	5¼	10	12	6¾	18



SV HUB & SPIGOT FITTINGS

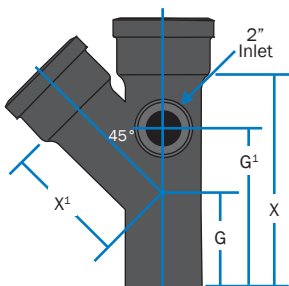

**WYE WITH RIGHT HAND SIDE INLET
(cup hub inlet)**

Part No.	Size	G	G ¹	X	X ¹	Wt.
002390	4" w/2"	5 ¹ / ₄	10	12	6 ³ / ₄	18

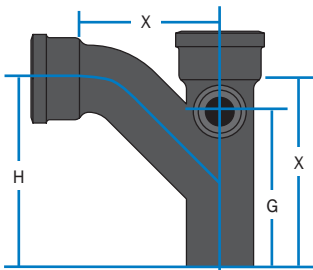

**COMBINATION WYE & 1/8 BEND
WITH SIDE INLET**

Part No.	Size	G	H	X	X ¹	Wt.
002413	4" w/2" RH	10	12 ¹ / ₁₆	12	9	28
002420	4" w/2" LH	10	12 ¹ / ₁₆	12	9	29

SV HUB & SPIGOT FITTINGS

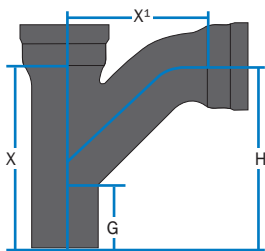

COMBINATION WYE & 1/8 BEND

Part No.	Size	X	G	X ¹	H	Wt.
001966	2"	8	4	4 ⁷ / ₈	7 ³ / ₈	8
001973	3 x 2"	9	4 ³ / ₁₆	5 ³ / ₄	8 ³ / ₁₆	12
001980	3"	10 ¹ / ₂	5	7	10 ¹ / ₁₆	14
001997	4 x 2"	9	3 ¹ / ₁₆	6 ¹ / ₄	8 ³ / ₁₆	12
002000	4 x 3"	10 ¹ / ₂	4 ¹ / ₂	7 ¹ / ₂	10 ¹ / ₁₆	18
002017	4"	12	5 ¹ / ₄	9	12 ¹ / ₁₆	22
002024	5 x 2"	9	3 ³ / ₈	6 ³ / ₄	8 ³ / ₈	15
383123	5 x 3"	10 ¹ / ₂	4	8	10 ¹ / ₁₆	22
002031	5 x 4"	12	4 ¹ / ₄	9 ¹ / ₂	7 ⁵ / ₁₆	24
002048	5"	13 ¹ / ₂	5 ¹ / ₂	11	11 ⁹ / ₁₆	30
002055	6 x 2"	9	2 ¹ / ₁₆	7 ¹ / ₄	8 ³ / ₁₆	17
002062	6 x 3"	10 ¹ / ₄	3 ¹ / ₈	8 ¹ / ₂	9 ¹ / ₁₆	19
002079	6 x 4"	12	4 ¹ / ₄	10	12 ¹ / ₁₆	23
388258	6 x 5"	13 ¹ / ₂	5 ¹ / ₁₆	11 ¹ / ₂	14 ³ / ₁₆	40
002086	6"	15	5 ³ / ₄	12 ⁷ / ₈	16 ¹ / ₁₆	45
383611	8 x 2"	10 ¹ / ₂	3 ¹ / ₈	8 ¹ / ₄	9 ⁵ / ₈	34
002093	8 x 4"	13 ¹ / ₂	4 ³ / ₄	11	13 ¹ / ₁₆	44
384748	8 x 5"	15	5 ¹ / ₂	12 ¹ / ₂	15 ⁵ / ₈	50
002109	8 x 6"	16 ¹ / ₂	6 ⁵ / ₁₆	13 ⁷ / ₈	17 ⁵ / ₈	60
002116	8"	19 ¹ / ₂	7 ¹ / ₁₆	17	21 ⁹ / ₁₆	85

SV HUB & SPIGOT FITTINGS

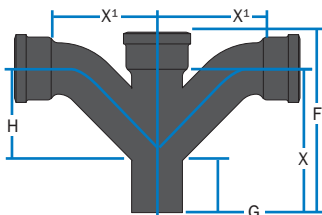

DOUBLE COMBINATION WYE & 1/8 BEND

Part No.	Size	X	H	X'	F	G	Wt.
002758	2"	8	3 ³ / ₈	4 ⁷ / ₈	7 ³ / ₈	4	12
002765	3 x 2"	9	4	5 ³ / ₄	8 ³ / ₁₆	4 ³ / ₁₆	14
002772	3"	10 ¹ / ₂	5 ¹ / ₁₆	7	10 ¹ / ₁₆	5	20
002789	4 x 2"	9	4 ¹ / ₂	6 ¹ / ₄	8 ³ / ₁₆	3 ¹ / ₁₆	16
002796	4 x 3"	10 ¹ / ₂	5 ⁹ / ₁₆	7 ¹ / ₂	10 ¹ / ₁₆	4 ¹ / ₂	23
002802	4"	12	6 ¹³ / ₁₆	9	12 ¹ / ₁₆	5 ¹ / ₄	34
101925	5 x 4"	12	7 ⁵ / ₁₆	9 ¹ / ₂	11 ¹ / ₁₆	4 ¹ / ₄	31
002819	6 x 4"	12	7 ¹³ / ₁₆	10	12 ¹ / ₁₆	4 ¹ / ₄	52
002826	6"	15	10 ⁵ / ₁₆	12 ⁷ / ₈	16 ¹ / ₁₆	5 ³ / ₄	80

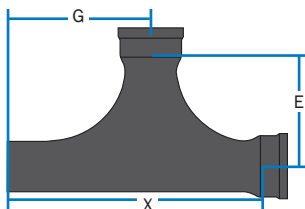

TWO-WAY CLEANOUT (Memphis Code)

Part No.	Size	X	E	G	Wt.
003465	4"	22 ¹ / ₈	9 ³ / ₈	12 ³ / ₄	35

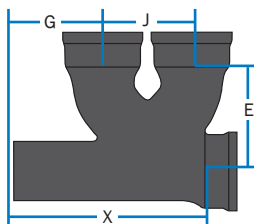

TWO-WAY DOUBLE CLEANOUT

Part No.	Size	X	E	G	J	Wt.
003519	4"	13 ⁵ / ₈	7 ¹ / ₂	6 ¹ / ₂	6 ⁷ / ₁₆	29
003533	6 x 4"	13 ⁵ / ₈	8 ¹ / ₂	6 ¹ / ₂	6 ⁷ / ₁₆	35

SV HUB & SPIGOT FITTINGS

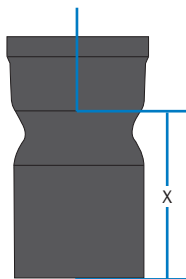

REDUCER

Part No.	Size	X	Wt.
003588	3 x 2"	4 ³ / ₄	5
003595	4 x 2"	5	6
003601	4 x 3"	5	7
383598	5 x 2"	5	6
383604	5 x 3"	5	7
003618	5 x 4"	5	8
003625	6 x 2"	5	9
003632	6 x 3"	5	7
003649	6 x 4"	5	11
003656	6 x 5"	5	9
003663	8 x 4"	6	13
003670	8 x 5"	6	14
003687	8 x 6"	6	17
003694	10 x 4"	6	20
383369	10 x 5"	6	21
003700	10 x 6"	6	24
003717	10 x 8"	6	27
003724	12 x 4"	6 ¹ / ₂	32
003731	12 x 6"	6 ¹ / ₂	34
003748	12 x 8"	6 ¹ / ₂	37
003755	12 x 10"	6 ¹ / ₂	38
003762	15 x 6"	6 ¹ / ₂	52
003779	15 x 8"	6 ¹ / ₂	50
003786	15 x 10"	6 ¹ / ₂	56
003793	15 x 12"	6 ¹ / ₂	65



SV HUB & SPIGOT FITTINGS

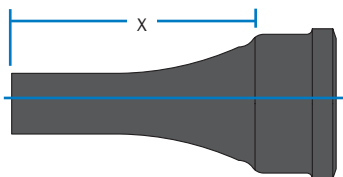

INCREASER

Part No.	Size	X	Wt.
045939	2 x 4"	9	10
003809	3 x 4"	9	9
003816	4 x 5"	9	12
003823	4 x 6"	9	16
003830	4 x 8"	12	25
277248	5 x 6"	9½	13
003847	6 x 8"	12	24
384724	8 x 10"	12	44
003854	10 x 12"	12	60
003861	12 x 15"	12	95

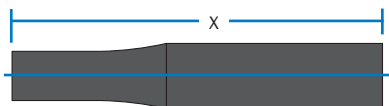

LONG PLAIN INCREASER

Part No.	Size	X	Wt.
003885	3 x 4"	24	14
003892	4 x 5"	30	24

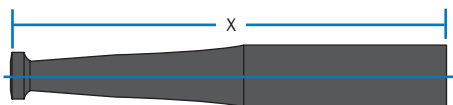

LONG TAPPED INCREASER

Part No.	Size	X	Wt.
003939	2 x 4"	24	15

SV HUB & SPIGOT FITTINGS

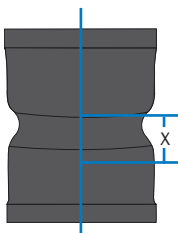

DOUBLE HUB FITTING

Part No.	Size	X	Wt.
003960	2"	1	4
003977	3"	1	6
003984	4"	1	8
003991	6"	1	11
384755	8"	1½	23
004004	10"	1½	37
384762	12"	1½	47
004011*	15"	1½	87

*XH only

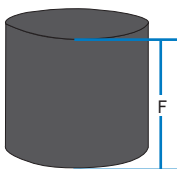

PIPE PLUG

Part No.	Size	F	Wt.
004035	2"	3½	1
004042	3"	3¾	2
004059	4"	4	4
004066	5"	4	6
004073	6"	4	6
004080	8"	4½	11
004097	10"	4½	17
004103	12"	5¼	31
004110*	15"	5¼	51

*XH only



SV HUB & SPIGOT FITTINGS

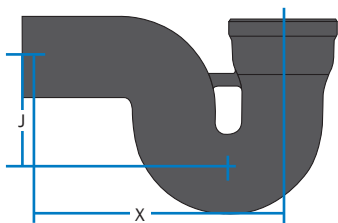

“P” TRAP

Part No.	Size	X	J	Wt.
004486	2"	9½	4	6
004493	3"	12	5½	12
004509	4"	14	6½	18
004516	5"	15½	7½	23
004523	6"	17	8½	33
004530	8"	22½	11½	87
004547	10"	25	14¾	113

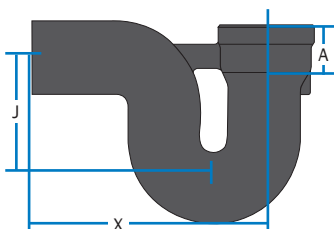

“P” TRAP WITH ½” HEEL TAP

Part No.	Size	X	J	A	Wt.
004813	2"	9½	4	3	8
004820	3"	12	5½	3½	13
004837	4"	14	6½	3½	18

SV HUB & SPIGOT FITTINGS

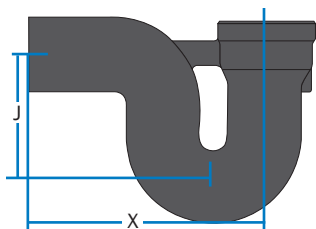

DEEP SEAL "P" TRAP

Part No.	Size	X	J	Wt.
004844	2"	9½	6	9
004851	3"	12	7	18
004868	4"	14	8	29
382614	6"	17	9½	41

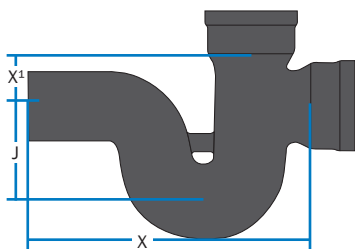

RUNNING TRAP WITH SINGLE HUB VENT

Part No.	Size	(Vent)	X	X'	J	Wt.
004615	3"	(3)	15	2½	5½	16
004622	4"	(4)	17½	3	6½	28
004639	5"	(4)	19½	3½	7½	40
004646	6"	(4)	21½	4	8½	46
004660	8"	(6)	27⅝	5¾	11	110



SV HUB & SPIGOT FITTINGS

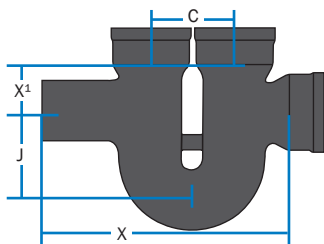

RUNNING TRAP w/ DOUBLE HUB VENTS

Part No.	Size	(Vent)	X	X'	C	J	Wt.
004707	3"	(3-3)	15	2½	5	5½	23
004714	4"	(4-4)	17½	3	6	6½	37
004721	5 x 4"	(4-4)	19½	3½	7	7½	43
004738	5"	(4-4)	19½	3½	7	7½	47
004745	6"	(4-4)	21½	4	8	8½	54
004752	6"	(6-6)	21½	4	8	8½	62
053880	8"	(4-4)	21½	4	8	8½	99
004769	8"	(6-6)	27⅝	5¼	10	11	100
004776	10"	(8-8)	31⅝	6¼	12	13	187
004783	12"	(10-10)	38¾	7¼	15	15	288
004790	15"	(12-12)	45¾	8¾	18½	18½	460

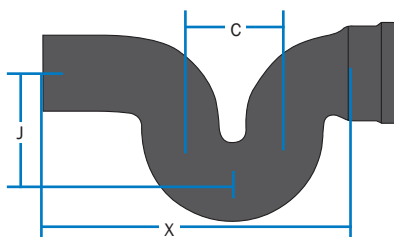

RUNNING TRAP

Part No.	Size	X	C	J	Wt.
004578	4"	17½	6	6½	19
004585	6"	21½	8	8½	65

SV HUB & SPIGOT FITTINGS

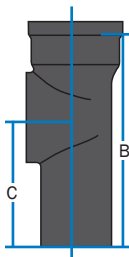

2-70 TEST TEE (SV Less Plug)

Part No.	Pipe Size	Tap Size	B	C	Wt.
024507	2"	2	8	6 $\frac{1}{4}$	6
024521	3"	3	10 $\frac{1}{8}$	7 $\frac{3}{8}$	10
024545	4"	3 $\frac{1}{2}$	11 $\frac{1}{8}$	8	14
024569*	4"	3 $\frac{1}{2}$	9	6 $\frac{1}{4}$	10
024583	4"	4	11 $\frac{1}{8}$	8	14
024576*	4"	4	9	6 $\frac{1}{4}$	10
024606	5"	5	11	7	22
024613	6"	6	13	8 $\frac{3}{4}$	26
024637	8"	8	16 $\frac{3}{8}$	11	47
024668	10"	10	17 $\frac{5}{8}$	11	73

2-70 TEST TEE WITH TYPE A PLUG

Part No.	Pipe Size	Tap Size	B	C	Wt.
024675	2"	2	8	6	6
024699	3"	3	10 $\frac{1}{8}$	7 $\frac{3}{8}$	11
024750	4"	3 $\frac{1}{2}$	11 $\frac{1}{8}$	8	18
024712*	4"	3 $\frac{1}{2}$	9	6 $\frac{1}{4}$	11
024774	4"	4	11 $\frac{1}{8}$	7	15
024736*	4"	4	9	6 $\frac{1}{4}$	-
024798	5"	5	11	7	11
024811	6"	6	13	8 $\frac{3}{4}$	28
024835	8"	8	16 $\frac{3}{8}$	11	51
383079**	12"	8	18 $\frac{1}{2}$	13	-

*Short Laying Length

** Southern Raised Head



SV HUB & SPIGOT FITTINGS

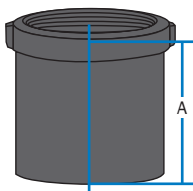

2-11 STANDARD FERRULE (less plug)

Part No.	Pipe Size	Tap Size	A	Wt.
023210	2"	1½	3¼	1
023234	3"	2½	3¾	2
023258	4"	3	3¼	3
023272	4"	3½	4¼	3
023296	5"	4	4¼	4
023319	6"	5	4¼	5
023333	8"	6	4½	11
023357	10"	6	4½	18
023388	12"	6	5¼	24
023364*	15"	6	5¼	45

*XH only

2-11 STANDARD FERRULE W/ TYPE A PLUG

Part No.	Pipe Size	Tap Size	A	Wt.
023395	2"	1½	3½	1
023425	3"	2½	3¾	3
023456	4"	3	3¼	4
023487	4"	3½	4¼	4
023517	5"	4	4¼	5
023548	6"	5	4¼	6
023586	8"	6	4½	13
023609	10"	6	4½	20
023630	12"	6	5¼	26
023616*	15"	6	5¼	47

*XH only

SV HUB & SPIGOT FITTINGS



CLOSET BENDS

Part No.	Size	Wt.
02896	4 x 4 x 14"	11
02894	4 x 4 x 16"	15
02898	4 x 4 x 18"	13
02904	4 x 6 x 12"	12
02908	4 x 6 x 15"	15
02914	4 x 6 x 16"	13
02912	4 x 6 x 18"	16
02924	4 x 10 x 12"	16
02932	4 x 10 x 15"	17
02934	4 x 10 x 16"	16
02936	4 x 10 x 18"	19
02938	4 x 12 x 12"	14
02940	4 x 12 x 14"	18
02944	4 x 12 x 16"	16
02946	4 x 12 x 18"	21
02950	4 x 16 x 16"	22
02954	4 x 18 x 18"	25

CLOSET BENDS (Reducing)

Part No.	Size	Wt.
02832	4 x 3 x 6 x 12"	10
02840	4 x 3 x 6 x 15"	10
02844	4 x 3 x 6 x 18"	13
02852	4 x 3 x 10 x 12"	12
02860	4 x 3 x 10 x 15"	16
02864	4 x 3 x 10 x 18"	16
02866	4 x 3 x 12 x 12"	16
02870	4 x 3 x 16 x 16"	18
02872	4 x 3 x 18 x 18"	25



SV HUB & SPIGOT FITTINGS



CLOSET BENDS REGULAR HUB

Part No.	Size	Length	Wt.
026136	4"	12	14
026146	4"	14	16
026156	4"	16	16
026167	4"	18	19

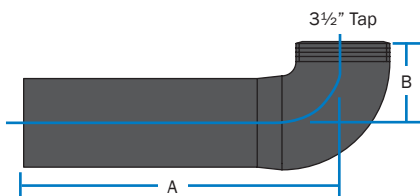

TAPPED CLOSET BEND WITH SOUTHERN CODE BRASS PLUG

Part No.	Size	A	B	Wt.
005803	3 1/2 x 4"	24	6 3/8	18

SV HUB & SPIGOT FITTINGS

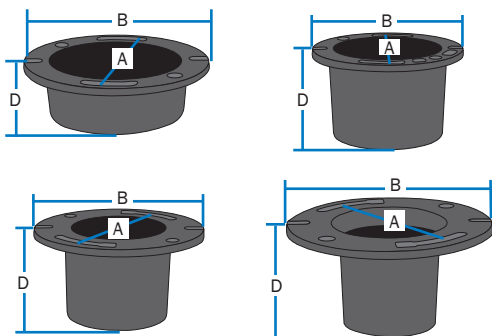

2-252 CLOSET FLANGE (Caulk Joint Application)

Part No.	Size x Height	A	B	D	Wt.
022848	4 x 1"	6 $\frac{1}{4}$	7 $\frac{1}{4}$	1	2
022855	4 x 1 $\frac{1}{2}$ "	6 $\frac{1}{4}$	7 $\frac{1}{4}$	1 $\frac{1}{2}$	2
8003	4 x 2"	6 $\frac{1}{4}$	7 $\frac{1}{4}$	2	2
8013*	4 x 2"	6 $\frac{3}{8}$	7 $\frac{1}{4}$	2	2.8
022879	4 x 2 $\frac{1}{2}$ "	6 $\frac{1}{4}$	7 $\frac{1}{4}$	2 $\frac{1}{2}$	3
022886	4 x 3"	6 $\frac{1}{4}$	7 $\frac{1}{4}$	3	4
8005	4 x 4"	6 $\frac{1}{4}$	7 $\frac{1}{4}$	4	5
022930*	4 x 4"	6 $\frac{1}{8}$	7 $\frac{1}{4}$	4	5
022909	4 x 5"	6 $\frac{1}{4}$	7 $\frac{1}{4}$	5	6
8017	4 x 6"	6 $\frac{1}{4}$	7 $\frac{1}{4}$	6	6
8015	4 x 2", 1" Offset	6	7	2	2.5
8018	4 x 4", 2" Offset	6 $\frac{1}{4}$	7 $\frac{1}{4}$	4	4.5
022947	4 x 3", 3" Reducing	6 $\frac{1}{4}$	7 $\frac{1}{4}$	3	3
8007	4 x 2"	6 $\frac{1}{4}$	7 $\frac{1}{4}$	2	3
8011	4 x 4 x 4"	6 $\frac{1}{4}$	7 $\frac{1}{4}$	4	4
8019	4 x 3 x 2 $\frac{1}{2}$ "	6 $\frac{1}{4}$	7 $\frac{1}{4}$	2 $\frac{1}{2}$	3

*Portland Code, two $\frac{1}{4}$ " taps on top.

Note: Adhesive lubricants are required for TY-SEAL and EZ-TITE gaskets in sizes 5 inch and larger diameters

SV HUB & SPIGOT FITTINGS

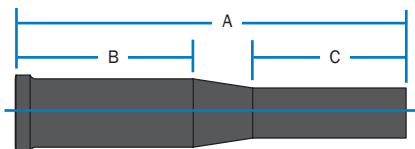

SISSION INSERTABLE JOINT

Part No.	Size	A	B	C	Wt.
428336	2"	14	6	6	7
124415	3"	16	8	6 ³ / ₄	12
124422	4"	14 ¹ / ₂	7	6	13
384731	5"	15 ⁷ / ₈	9	5 ⁷ / ₈	17
383178	6"	16 ³ / ₁₆	8 ¹ / ₂	6	21
102717	8"	18	10	6 ³ / ₄	37



TAPPED SPIGOT

Part No.	Size	X	Wt.
111719	4 x 2"	4 ¹ / ₄	5

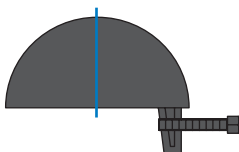

VENT CAP WITH SET SCREW

Part No.	Size	Wt.
014591	4"	3

SV HUB & SPIGOT FITTINGS

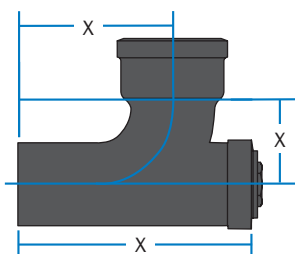

**SANITARY TEE WITH
CLEANOUT ON MAIN**

Part No.	Size	IPS Tap	G	X	X1	Wt.
112822	4"	3½	8	12⅛	4½	17

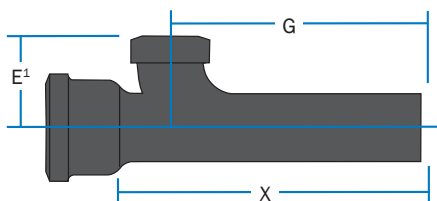

LONG SANITARY TAPPED TEE

Part No.	Size	G	X	X¹	Wt.
380016	2 x 2 x 18"	16	18	3⅜	9

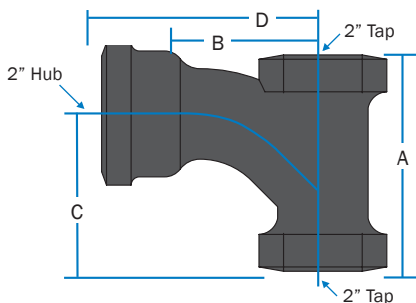

TAPPED LONG SWEEP TEE

Part No.	Size	A	B	C	D	Wt.
005773	2 x 2"	5½	3⅜	4	5⅝	7

SV HUB & SPIGOT FITTINGS

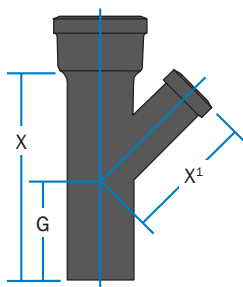

TAPPED WYE

Part No.	Size	G	X	X ¹	Wt.
003236	3 x 2"	4	9	6 ⁵ / ₈	11
003243	4 x 1½"	5¼	9	7 ⁷ / ₈	11
003250	4 x 2"	5¼	9	6 ⁷ / ₈	13

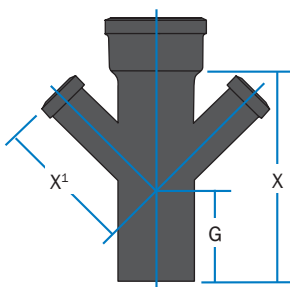

TAPPED DOUBLE WYE

Part No.	Size	G	X	X ¹	Wt.
003441	4 x 2"	5¼	9	7 ⁷ / ₈	16

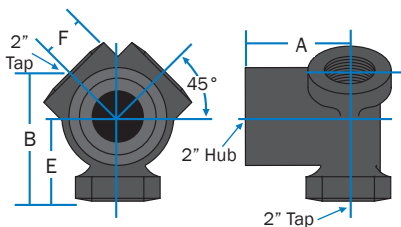

TAPPED BATH VENT WYE

Part No.	Size	A	B	C	D	Wt.
005766	2"	4 ¹ / ₁₆	5 ⁵ / ₆₄	3 ³ / ₄	2 ¹ / ₂	9

SV HUB & SPIGOT FITTINGS

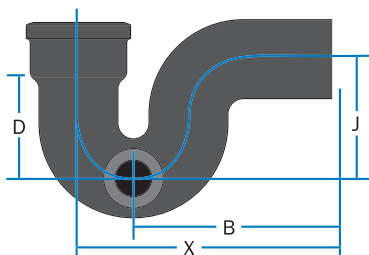

**“P” TRAP WITH CLEANOUT
RIGHT SIDE**

Part No.	Size	X	J	B	D	Wt.
384779	4"	14	6½	20	11	20

NOTE: 3½" IPS tap.

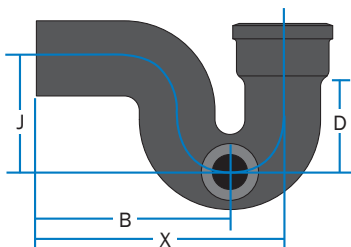

**“P” TRAP WITH CLEANOUT
LEFT SIDE**

Part No.	Size	X	J	B	D	Wt.
384786	4"	14	6½	11	5½	20

NOTE: 3½" IPS tap.

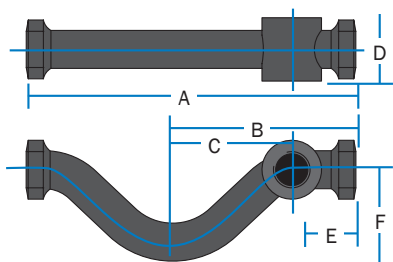

VENT BYPASS WITH 2 TAPPED SIDES

Part No.	Size	A	B	C	D	E	F	Wt.
005780	2 x 2"	18	10	6½	3¾	3	5¼	12



SV HUB & SPIGOT FITTINGS

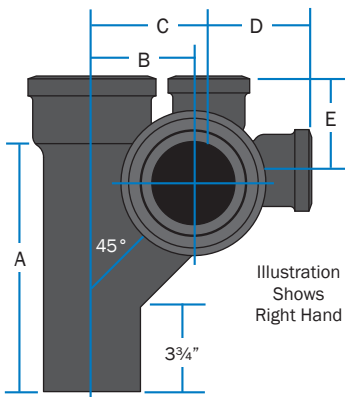

SV-458 VENTED CLOSET TEE WITH 2" TOP VENT AND 2" EXTENDED SIDE INLET, RIGHT HAND OR LEFT HAND

Part No.	Size	A	B	C	D	E	Wt.
005575	4x4x2x2x4"RH	11		4½	5⅜	4⅞	37
005582	4x4x2x2x4"LH	11		4½	5⅜	4⅞	38

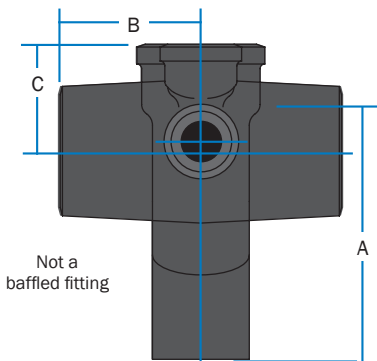

SV-459D VENTED CLOSET CROSS W/ 2" TOP VENT AND 2" EXTENDED SIDE INLET

Part No.	Size	A	B	C	Wt.
005599	4x4x2x2x4"	11	6¼	4¾	47

SV HUB & SPIGOT FITTINGS

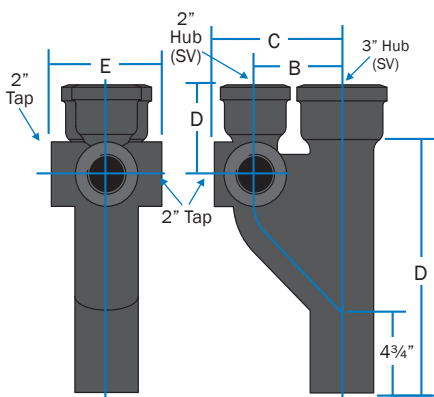

DOUBLE SINK STACK-770C

Part No.	Size	A	B	C	D	E	Wt.
005827	3x2"	15½	4½	6⅝	4½	5¾	18
005834	4x2"	15½	5¾	7⅞	4½	—	22

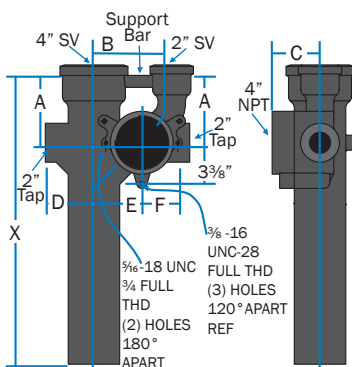

SV 973R RIGHT HAND STARTER FITTING WITH 4" TAP AND 2" TAPPED "A" SIDE INLET

Part No.	Size	Inlet	A	B	C	D	E	F	X	Wt.
107163	4"	6½	6½	6½	4	4⅞	4	4	25	35
107170	4"	9½	9½	6½	4	4⅞	4	4	25	35

AB&I Foundry
800/GOT-IRON • ABIFoundry.com

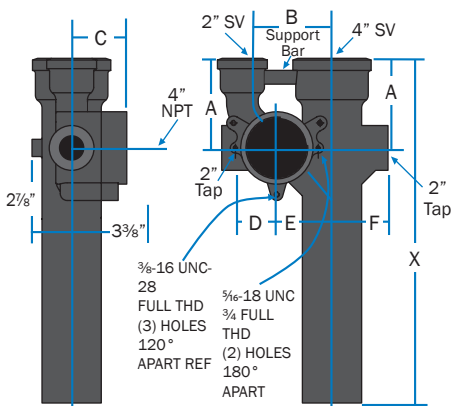

SV 973L LEFT HAND STARTER FITTING WITH 4" TAP AND 2" TAPPED "A" SIDE INLET

Part No.	Size	Inlet	A	B	C	D	E	F	X	Wt.
107194	4"	6½	6½	6½	4	4	4	4	25	39
107217	4"	9½	9½	6½	4	4	4	4	25	39

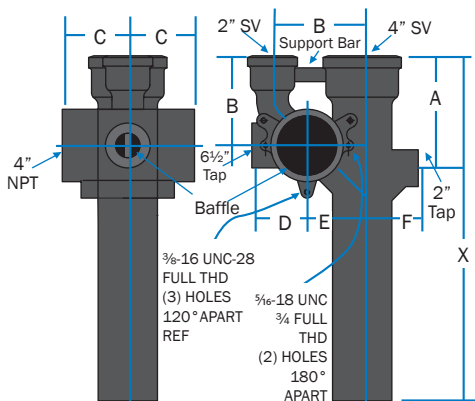

SV 975 DOUBLE STARTER FITTING WITH 4" TAP AND 2" TAPPED "A" SIDE INLET

Part No.	Size	A	B	C	D	E	F	X	Wt.
107255	4"	9½	6½	4	4	4	4¼	25	43

STARTER FITTINGS

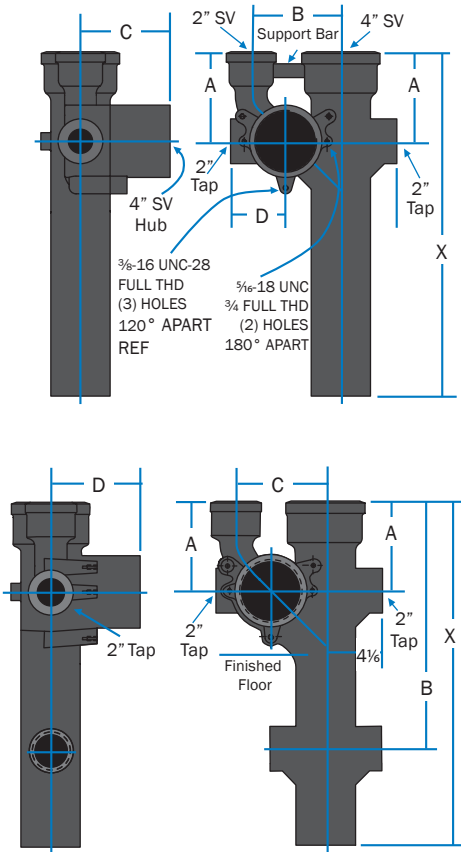

SV 974L LEFT HAND STARTER FITTING WITH 4" HUB

Part No.	Size	A	B	C	D	X	Wt.
107248	4" with A inlets	6½	0	6½	4	25	39
011093	4" with A & B inlets	6½	18	6½	4	25	44

AB&I Foundry
 800/GOT-IRON • ABIFoundry.com

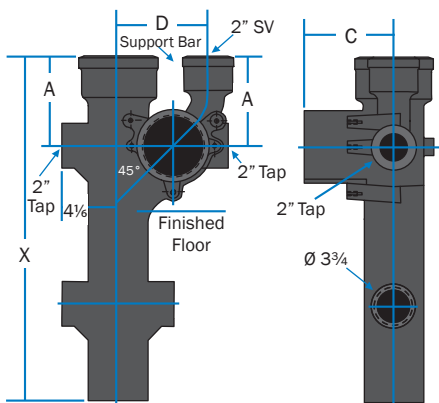
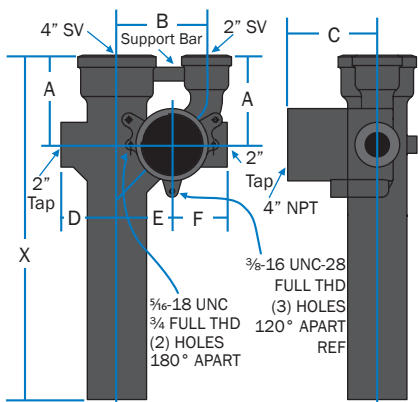

SV 974R RIGHT HAND STARTER FITTING WITH 4" HUB

Part No.	Size	A	B	C	D	E	F	Wt.
107231	4" with A inlets	6½	0	6½	4¼	4	25	39
011094	4" with A & B inlets	6½	18	6½	4¼	4	25	46

STARTER FITTINGS

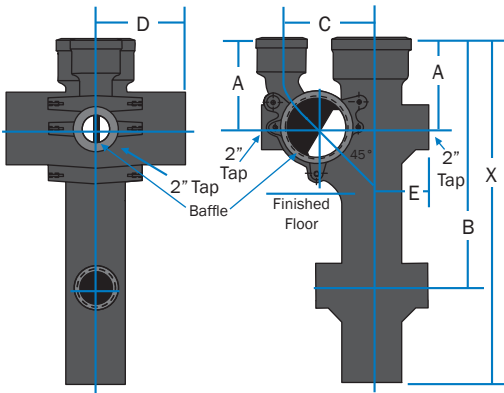
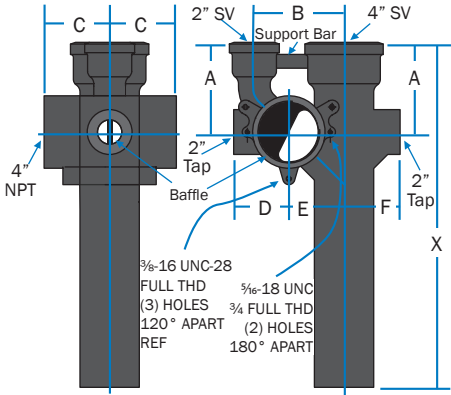

SV 976 DOUBLE STARTER FITTING WITH 4" HUB AND 2" TAPPED "A" SIDE INLET

Part No.	Size	A	B	C	D	E	X	Wt.
107262	4" with A inlets	6½	0	6½	4	4	25	51
011095	4" with A & B inlets	6½	18	6½	4	4	25	59

AB&I Foundry
800/GOT-IRON • ABIFoundry.com

TRIM PACKAGE FOR STARTER FITTINGS

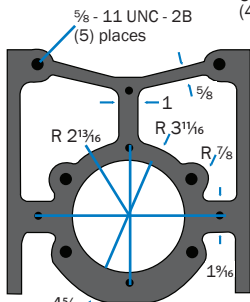
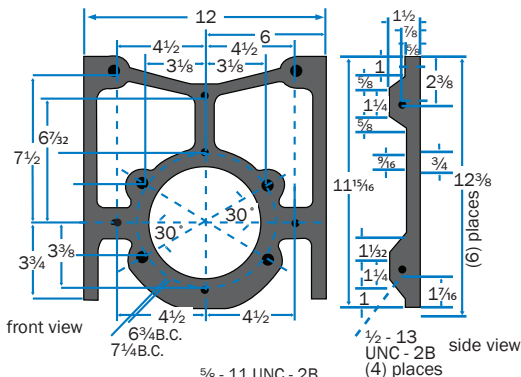
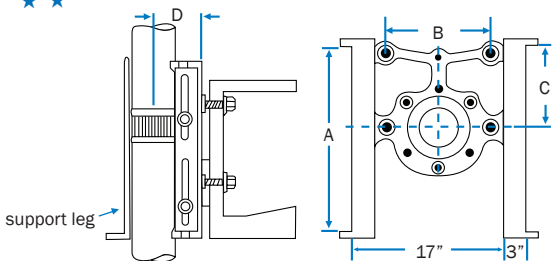

EZS 22 EXTENDED LEG (left or right)

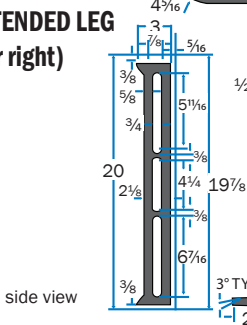

EZS 22 SUPPORT LEG

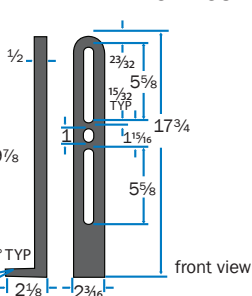

TRIM PACKAGE FOR STARTER FITTINGS

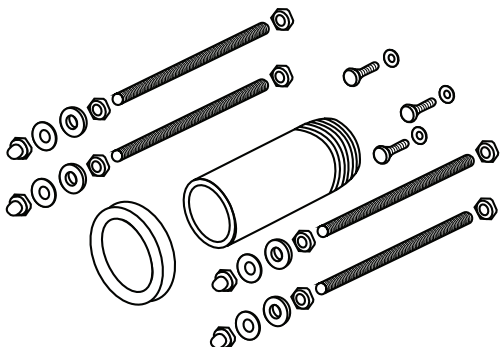

EZS 22 AND EZS 24 INSTALLATION INSTRUCTIONS

1. IDENTIFY THE MAJOR COMPONENTS OF THE EZS 24 TRIM PACKAGE AND EZS 22 SUPPORT FRAME.
2. SECURE EZS 22 SUPPORT FRAME TO INSTALLED STARTER FITTING USING $\frac{3}{8}$ " X $1\frac{1}{2}$ " BOLTS AND $\frac{3}{8}$ " FLAT WASHERS.
3. SECURE RIGHT AND LEFT LEGS TO THE EZS 22 FACEPLATE USING $\frac{1}{2}$ " X $1\frac{1}{4}$ " BOLTS AND $\frac{1}{2}$ " FLAT WASHERS IN POSITION SHOWN TO THE RIGHT.
4. ADJUST ASSEMBLY TO THE DESIRED HEIGHT. LEVEL AND ALIGN THE ASSEMBLY.
5. SECURE THE FEET OF THE EZS 22 SUPPORT FRAME TO THE FLOOR USING THE $\frac{1}{2}$ " X $1\frac{1}{4}$ " BOLTS SUPPLIED.
6. SECURE SUPPORT LEG. FOR DOUBLE STARTER FITTINGS, THE SUPPORT LEG IS NOT REQUIRED.
7. SECURE $\frac{5}{8}$ " X 12" EZS 24 THREAD RODS TO FACEPLATE ACCORDING TO EZS 22 FACEPLATE.
8. INSTALL EZS 24 THREADED NIPPLE TO THE EZS 700 OR EZS 800 FITTING.

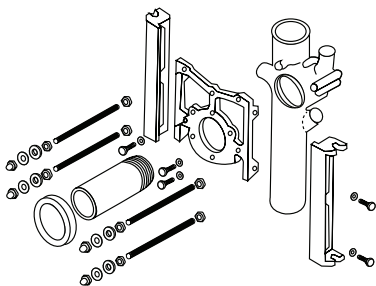

EZS 23

Part No.: 76045

TRIM PACKAGE, FLOOR-MOUNTED BACK-OUTLET ASSEMBLY
(note: not to be used with PART NO. EZS 22 support frame assembly)

- 1 – 4" PVC Sch. 80 NIPPLE with TEST CAP
- 1 – BOWL GASKET
- 2 – 5/16" X 12" RODS
- 2 – 5/16" HEX NUTS
- 2 – 5/16" FLAT WASHERS
- 2 – 5/16" CAP NUTS

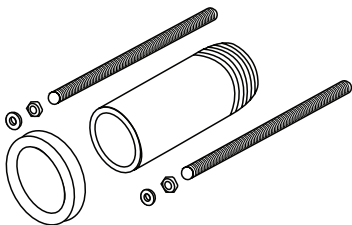

EZS 24

Part No.: 76050

TRIM PACKAGE, WALL-HUNG BACK-OUTLET ASSEMBLY
(to be used with PART NO. EZS 22 support frame assembly)

- 1 – 4" PVC Sch. 80 NIPPLE with TEST CAP
- 1 – BOWL GASKET
- 4 – 5/8" X 12" RODS
- 4 – 5/8" CHROME CAP NUTS
- 8 – 5/8" JAM NUTS
- 4 – 5/8" FLAT WASHERS
- 4 – 5/8" FIBER WASHERS
- 3 – 3/8" X 1 1/2" BOLTS FOR FACEPLATE
- 3 – 3/8" FLAT WASHERS
- 4 – 5/8" STAR WASHERS



TY-SEAL

Part No.	Size	Wt. Ea.	Carton	Pallet	Quantity	Wt.
		Lbs.	Quantity	Wt.		
004875	2"	0.3	60	18	2880	900
004882	3"	0.4	40	16	1600	675
004899	4"	0.6	40	24	1280	805
004905	5"	1.2	30	35	600	735
004912	6"	1.4	30	40	600	835
004929	8"	1.6	20	30	320	151
004936	10"	2.0	10	18	270	520
004943	12"	2.5	10	22	270	630
014959	15"	3.8	10	38	120	490



EZ-TITE

Part No.	Size	Wt. Ea.	Carton	Pallet	Quantity	Wt.
		Lbs.	Quantity	Wt.		
004950	2"	0.3	60	18	2880	900
004967	3"	0.4	40	16	1600	675
004974	4"	0.6	40	24	1280	805
004981	5"	1.2	30	35	600	735
004998	6"	1.4	30	40	600	835



TY-SEAL LUBRICANT

Part No.	Size	Wt.
005117	Quart	2.5

- An excellent water-soluble joint compound, TY-SEAL LUBRICANT has demonstrated its efficiency in millions of joints.
- Quick and easy to use under all conditions... Even under water!

LUBRI/FAST® LUBRICANT

Part No.	Size	Wt.
005110	Quart	2.5

LUBRI/FAST®

- The unique LUBRI/FAST® formula makes joining TY-SEAL gaskets easier and faster because it's so slick! Applied as a liquid, LUBRI/FAST® actually reduces joining forces required; then it literally "fastens" the joint.
- LUBRI/FAST® is applied with an ordinary paint brush. It may be used for joining all pipe and fittings, and is required for joining all larger diameters 5" through 15".

TY-TOOLS

Part No.	Description	Joins Pipe Size	Wt.
005223	4" w/4 x 2 & 4 x 3 adapter	2", 3", 4"	21
005438	6" w/6 x 4 adapter	4", 6"	29
005580	8" w/8 x 6 adapter	6", 8"	40

IMPORTANT NOTICE:

AB&I will not be held accountable for any delays caused by work stoppage, trucking delays, raw material availability, acts of God or other unnatural causes beyond AB&I Foundry's immediate control.

WARRANTY

AB&I products are guaranteed to be free from defects in material and workmanship, and to conform to applicable standards and requirements. AB&I's liability is limited to the replacement of defective material acknowledged by AB&I to be defective, and presented for claim within reasonable time limits. Material found defective will only be replaced; no labor charges or damages will be allowed.

WARNING! Testing with compressed air or gas in Cast Iron pipe and fittings may result in explosive failure and could cause severe injury or death. AB&I Foundry recommends hydrostatic testing as described in the CISPI Handbook. **Never test Cast Iron pipe or fittings with compressed air or gas!**

We certify that the cast iron soil pipe and fittings bearing our "AB&I" and "CI" markings are American manufactured and conform to the following specifications and reference standards:

- ASTM A-888
- ASTM C-564
- DOD-4270
- ANSI A112.5.1
- ICC 1080
- Federal Specification WWP 401F
- Certified by NSF to CISPI 301 & ASTM A74
- ASTM A-74, SV Hub & Spigot Reference Standard
- CISPI 301
- IAPMO File No. 3270
- CISPI H-74
- ICC 1079



Cast Iron: A Truly Green Building Product

AB&I uses post consumer recycled scrap iron as the raw material in their manufacturing process. AB&I's cast iron soil pipe & fittings are a sustainable plumbing product and reusable in its entirety.

AB&I pipe & fittings make a major positive contribution to the local environment, relieving the load on landfills and reducing the demand for energy by eliminating the need to mine and refine iron ore.

Distribution Centers Nationwide

We understand that product availability and fast delivery are critically important to distributors and contractors alike. That's why AB&I has established a nationwide network of distribution centers that put the full range of AB&I products in close proximity. To learn more about our locations, visit our website.

AB&I FOUNDRY
800/GOT-IRON (468-4766)
ABIFoundry.com